





# NOVO HORIZONTE ALUMÍNIOS

## **Missão:**

*Identificar e atender de maneira eficiente às necessidades e expectativas de nossos clientes; oferecendo produtos e serviços de qualidade com garantia, segurança e rapidez.*

*A Novo Horizonte Aluminios, vem conquistando espaço no mercado de extrudados de alumínio, através do fornecimento de produtos com qualidade, prazo de entrega reduzido, suporte no desenvolvimento de produtos específicos para atender as necessidades de seus clientes.*

*Instalada em Cambé, PR, em uma área de 4.500 m<sup>2</sup>, a Novo Horizonte Aluminios conta com estrutura composta de equipamentos sofisticados, configurados com as melhores tecnologias disponíveis para o segmento. Desta forma garantimos atender ao mesmo tempo os requisitos técnicos do produto e os critérios de qualidade exigidos pelo mercado. Nas instalações da Novo Horizonte Aluminios, um novo produto solicitado é projetado em softwares avançados, e o ferramental executado em equipamentos de usinagem e erudição dinâmicos, com alta produtividade e minuciosa precisão, aliado a um corpo técnico devidamente capacitado, garantindo ao cliente a rapidez que ele precisa para atender o mercado em que atua.*

*Com o objetivo de garantir rapidez na entrega a empresa mantém internamente um Centro de Distribuição com produtos de alto giro, além de frota própria, que contribui para a eficiência logística. Os produtos após rigorosa inspeção são embalados de forma a garantir a sua qualidade durante o manuseio e transporte. Todo volume é identificado com os dados básicos possuindo também a informação de produção que garante toda a rastreabilidade do processo.*

**Com tudo isso, sua satisfação como cliente é garantida!**



**NOVO  
HORIZONTE**  
ALUMÍNIOS

## ÍNDICE

<b>A</b>	<b>AQUECEDOR</b>	<b>48</b>
	<b>ARO PARA BICICLETA</b>	<b>19-20</b>
<b>B</b>	<b>BARCO</b>	<b>17-18</b>
	<b>BARRA CHATA</b>	<b>11</b>
<b>C</b>	<b>CAMINHÃO – TRILHO PARA CABINES</b>	<b>20</b>
	<b>CAMINHÃO – PROTEÇÃO LATERAL</b>	<b>21-25</b>
	<b>CAMINHÃO – DIVERSOS</b>	<b>26-29</b>
	<b>CAMINHÃO – TIRA FINA</b>	<b>30</b>
	<b>CANTONEIRA ABAS DESIGUAIS</b>	<b>9</b>
	<b>CANTONEIRAS ABAS IGUAIS</b>	<b>9</b>
	<b>CANTONEIRAS ARREDONDADAS ABAS IGUAIS</b>	<b>10</b>
<b>E</b>	<b>ESCADAS</b>	<b>16</b>
<b>F</b>	<b>FERRAGEM</b>	<b>42-45</b>
	<b>FOTOVOLTAICO</b>	<b>31</b>
<b>L</b>	<b>LINHA CIVIL</b>	<b>12-14</b>
	<b>LINHA CASE</b>	<b>31</b>
	<b>LINHA DOMÉSTICA (TRILHOS)</b>	<b>15-16</b>
	<b>LINHA GRADIL</b>	<b>46</b>
	<b>LINHA SEGURANÇA</b>	<b>47</b>
<b>M</b>	<b>MODULO ESPECIAL</b>	<b>60-61</b>
	<b>MOVELEIRA</b>	<b>33-41</b>
<b>P</b>	<b>PERFIL “U” ABAS DESIGUAIS</b>	<b>10</b>
	<b>PERFIL “U” ABAS IGUAIS</b>	<b>10</b>
<b>T</b>	<b>TEMPERADO</b>	<b>49-56</b>
	<b>TRILHO PANTOGRÁFICO</b>	<b>57-59</b>
	<b>TUBO ELIPTICO</b>	<b>7</b>
	<b>TUBO QUADRADO</b>	<b>6</b>
	<b>TUBO QUADRADO – CANTOS ARREDONDADOS</b>	<b>6</b>
	<b>TUBO REDONDO ESTRIADO</b>	<b>5</b>
	<b>TUBO REDONDO LISO</b>	<b>4-5</b>
	<b>TUBO RETANGULAR</b>	<b>7</b>
<b>V</b>	<b>VENEZIANA</b>	<b>57</b>
	<b>VERGALHÃO QUADRADO</b>	<b>8</b>
	<b>VERGALHÃO REDONDO</b>	<b>8</b>

### OBSERVAÇÕES:

- ✓ PRODUTOS COM CÓDIGO SUBLINHADO, É COMERCIALIZADO NO QUILO SOB DEMANDA. FAVOR CONSULTAR A QUANTIDADE MÍNIMA ANTES DA CONCLUSÃO DA VENDA. EXEMPLO: 600018738
- ✓ TODOS OS ITENS DO CATÁLOGO ESTÃO SUJEITOS A VARIAÇÃO DE PESO DE  $\pm 5\%$
- ✓ TODOS OS DESENHOS DE PRODUTOS ESTÃO EM ESCALA 1:1 (APROXIMADA)
- ✓ TRABALHAMOS COM DESENVOLVIMENTO DE FERRAMENTAS COM APLICAÇÕES ESPECÍFICAS. PROCURE NOSSO DEPARTAMENTO COMERCIAL.

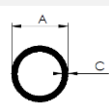

## TUBO REDONDO LISO

CÓDIGO	PESOS*		MILÍMETRO		POLEGADA		EMBALAGEM PADRÃO (BARRAS)
	kg/m	BARRA 6 m	A	C	A	C	
<u>600010012</u>	0,075	0,450	7,94	1,35	5/16	1,35	50
<u>600010004</u>	0,069	0,414	9,52	0,90	3/8	-	50
<u>600011052</u>	0,094	0,564	9,52	1,25	3/8	-	20
<u>600018738</u>	0,166	1,050	9,52	3	3/8	-	20
<u>600010006</u>	0,104	0,624	12,7	1,0	½	-	20
<u>600018740</u>	0,136	0,816	12,7	1,35	1/2	-	20
<u>600010818</u>	0,158	0,948	12,7	1,6	1/2	1/16	20
<u>600018664</u>	0,074	0,504	14,29	0,7	9/16	-	50
<u>600018663</u>	0,103	0,618	14,29	0,85	9/16	-	50
<u>600012916</u>	0,160	0,960	14,29	1,4	9/16	-	30
<u>600018589</u>	0,120	0,720	15,87	0,8	5/8	-	30
<u>600010027</u>	0,169	1,014	15,87	1,3	5/8	-	30
<u>600010002</u>	0,180	1,080	15,87	1,4	5/8	-	30
<u>600012137</u>	0,204	1,224	15,87	1,6	5/8	1/16	30
<u>600018746</u>	0,247	1,482	15,87	2,0	5/8	-	20
<u>600014172</u>	0,300	1,800	15,87	2,5	5/8	-	20
<u>600010034</u>	0,107	0,642	19,05	0,65	¾	-	30
<u>600011591</u>	0,129	0,774	19,05	0,8	3/4	-	30
<u>600011592</u>	0,162	0,972	19,05	1	3/4	-	30
<u>600010026</u>	0,206	1,236	19,05	1,3	3/4	-	20
<u>600018741</u>	0,220	1,320	19,05	1,4	3/4	-	20
<u>600013903</u>	0,250	1,500	19,05	1,6	3/4	1/16	20
<u>600010010</u>	0,315	1,890	19,05	2,0	3/4	-	20
<u>600010031</u>	0,125	0,750	22,22	0,65	7/8	-	20
<u>600010025</u>	0,154	0,924	22,22	0,8	7/8	-	20
<u>600012203</u>	0,190	1,140	22,22	1	7/8	-	20
<u>600010001</u>	0,260	1,560	22,22	1,4	7/8	-	20
<u>600011615</u>	0,294	1,764	22,22	1,6	7/8	1/16	20
<u>600010015</u>	0,401	2,406	22,22	2,0	7/8	-	15

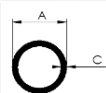

## TUBO REDONDO LISO

CÓDIGO	PESOS*		MILÍMETRO		POLEGADA		EMBALAGEM PADRÃO(BARRAS RAS)
	kg/m	BARRA 6 m	A	C	A	C	
600010028	0,177	1,062	25,4	0,8	1	-	20
600018731	0,218	1,308	25,4	1	1	-	20
600018742	0,304	1,824	25,4	1,4	1	-	20
600011560	0,336	2,016	25,4	1,6	1	1/16	15
600018733	0,418	2,508	25,4	2	1	-	10
<u>600018732</u>	0,600	3,600	25,4	3	1	-	10
<u>600010035</u>	0,150	0,900	28,58	0,65	1,1/8	-	12
<u>600018611</u>	0,195	1,170	28,58	0,8	1.1/8	-	12
<u>600018610</u>	0,247	1,485	28,58	1	1.1/8	-	12
<u>600010008</u>	0,315	1,890	28,58	1,3	1.1/8	.	12
<u>600018609</u>	0,276	1,656	31,75	1	1.1/4	-	12
600010007	0,378	2,268	31,75	1,4	1.1/4	-	15
<u>600012200</u>	0,430	2,583	31,75	1,6	1.1/4	1/16	12
<u>600012202</u>	0,534	3,204	31,75	2	1.1/4	-	10
<u>600018745</u>	0,554	3,324	33,8	1,95	-	-	6
<u>600018735</u>	0,333	1,999	38,1	1	1.1/2	-	16
<u>600012201</u>	0,491	2,946	38,1	1,5	1.1/2	-	12
<u>600010033</u>	0,800	4,800	38,1	2,65	1.1/2	-	6
<u>600010017</u>	1,390	8,340*	48,00	3,5	-	-	3
<u>600010032</u>	0,610	3,660	44,45	1,6	1,3/4	1/16	8
600011104	0,535	3,210	50,8	1,2	2	-	6
600018739	0,787	4,725	50,8	1,8	2	-	6
<u>600010037</u>	2,717	16,302	80,0	4,0	-	-	2

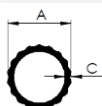

## TUBO REDONDO ESTRIADO

CÓDIGO	PESOS*		MILÍMETRO		POLEGADA		EMBALAGEM PADRÃO(BARRAS )
	kg/m	BARRA 6 m	A	C	A	C	
600010013	0,120	0,720	22,22	0,95	7/8	-	20
600010014	0,141	0,846	25,40	0,95	1	-	15
600010036	0,173	1,038	28,0	0,65	-	-	20
<u>600010029</u>	0,175	1,050	28,58	0,65	1.1/8	-	10
<u>600010459</u>	0,210	1,260	28,58	1	1.1/8	-	10
<u>600010030</u>	0,195	1,170	31,75	0,65	1.1/4	-	10
600010458	0,231	1,386	31,75	1	1.1/4	-	10

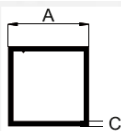

## TUBO QUADRADO

CÓDIGO	PESOS*		MILÍMETRO		POLEGADA		EMBALAGEM PADRÃO(BARRAS )
	kg/m	BARRA 6 m	A	C	A	C	
601060001	0,192	1,152	15,88	1,1	5/8	-	20
601060002	0,300	1,800	19,05	1,5	3/4	-	20
<u>601068711</u>	0,308	1,848	19,5	1,5	-	-	16
601060009	0,178	1,068	23,0	0,7	-	-	15
601063492	0,193	1,158	25,0	0,7	-	-	15
601068244	0,330	1,980	25,4	1,2	1	-	16
601062967	0,408	2,448	25,4	1,5	1	-	12
<u>601060004</u>	0,228	1,764	29,4	0,7	-	-	12
601068528	0,418	2,508	31,75	1,2	1.1/4	-	12
<u>601060008</u>	0,902	5,412	31,75	2,8	1.1/4	-	6
<u>601062168</u>	0,341	2,046	38,1	0,85	1.1/2	-	12
601067688	0,504	3,024	38,1	1,2	1.1/2	-	12
601063344	0,625	3,750	38,1	1,5	1.1/2	-	9
<u>601060013</u>	1,257	7,542	38,1	3,0	1.1/2	-	4
<u>601060011</u>	0,390	2,658	40,0	1	-	-	9
601060005	0,676	4,056	50,8	1,2	2	-	6
601068469	0,733	4,398	50,8	1,3	2	-	6
601060003	0,800	4,800	50,8	1,5	2	-	6
<u>601063720</u>	0,977	5,862	50,8	1,75	2	-	6

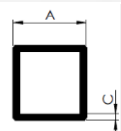

## TUBO QUADRADO - CANTOS ARREDONDADOS

CÓDIGO	PESOS*		MILÍMETRO		POLEGADA		EMBALAGEM PADRÃO(BARRAS)
	kg/m	BARRA 6 m	A	C	A	C	
601068736	0,357	2,142	25,4	1,3	1	-	10
<u>601062968</u>	0,532	3,194	25,4	2	1	-	12

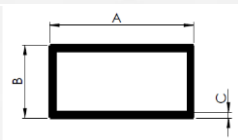

## TUBO RETANGULAR

CÓDIGO	PESOS*		MILÍMETRO			POLEGADA			EMBALAGEM PADRÃO(BARRAS)
	kg/m	BARRA 6 m	A	B	C	A	B	C	
601071590	0,154	0,930	25,4	12,7	0,75	1	1/2	-	30
<u>601070016</u>	0,263	1,578	25,4	12,7	1,3	1	1/2	-	15
<u>601071674</u>	0,523	3,138	30	20	2,0	-	-	-	10
601070013	0,331	1,806	50,8	9,52	1,0	2	3/8	-	3
601071589	0,313	1,878	50,8	25,4	0,7	2	1	-	10
601070006	0,584	3,504	50,8	25,4	1,4	2	1	-	10
601071588	0,665	3,990	50,8	25,4	1,6	2	1	1/16	8
601070003	0,919	5,514	76,2	38,1	1,45	3	1.1/2	-	4
601070007	1,148	6,888	101,6	50,8	1,35	4	2	-	3
<u>601071593</u>	1,260	7,560	50	30	3,0	-	-	-	3

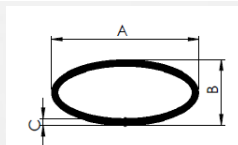

## TUBO ELIPTICO

CÓDIGO	PESOS*		MILÍMETRO			EMBALAGEM PADRÃO(BARRAS)
	kg/m	BARRA 6 m	A	B	C	
601110001	0,378	2,268	35	20	1,6	10
<u>601110008</u>	0,395	2,370	45	21	1,4	10
<u>601110002</u>	0,457	2,742	45	20	1,6	10
<u>601110003</u>	0,510	3,061	45	20	1,8	10
<u>601110007</u>	0,490	2,940	46,7	22	1,6	10



## VERGALHÃO QUADRADO\*

CÓDIGO	PESOS		MILÍMETRO	POLEGADA	EMBALAGEM PADRÃO(BARRAS)
	kg/m	BARRA 6 m	A	A	
<a href="#">601100269</a>	0,103	0,617	6	-	10
<a href="#">601100001</a>	0,180	1,080	7,93	5/16	10
<a href="#">601100007</a>	0,258	1,548	9,53	3/8	20
<a href="#">601107465</a>	0,447	2,682	12,7	½	10
<a href="#">601108759</a>	0,714	4,284	15,87	5/8	8
<a href="#">601100008</a>	1,403	8,418	22,22	7/8	6

Material impróprio para grandes usinagens (Liga 6063 T5)

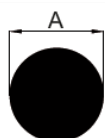

## VERGALHÃO REDONDO\*

CÓDIGO	PESOS		MILÍMETRO	POLEGADA	EMBALAGEM PADRÃO(BARRAS)
	kg/m	BARRA 6 m	A	A	
<a href="#">601100005</a>	0,068	0,408	5,5	-	10
<a href="#">601107659</a>	0,081	0,486	6,0	-	10
<a href="#">601101675</a>	0,090	0,540	6,35	1/4	10
<a href="#">601108641</a>	0,141	0,846	7,94	5/16	10
<a href="#">601107561</a>	0,203	1,218	9,52	3/8	10
<a href="#">601100009</a>	0,276	1,656	11,11	7/16	15
<a href="#">601101676</a>	0,360	2,160	12,7	1/2	10
<a href="#">601100002</a>	0,560	3,360	15,87	5/8	10
<a href="#">601108758</a>	0,810	4,860	19,05	3/4	8
<a href="#">601100003</a>	1,099	6,594	22,22	7/8	6
<a href="#">601100004</a>	1,436	8,616	25,4	1	4
<a href="#">601100006</a>	5,760	11,520**	50,8	2	2

\*Material impróprio para grandes usinagens (Liga 6063 T5)(\*\*) barras somente com 2 metros.

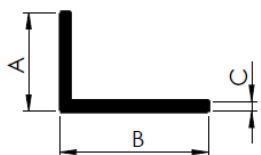

## CANTONEIRA ABAS DESIGUAIS

CÓDIGO	PESOS*		MILÍMETRO			EMBALAGEM PADRÃO(BARRAS)
	kg/m	BARRA 6 m	A	B	C	
<a href="#">601000012</a>	0,305	1,830	12,0	38,0	2,3	16
<a href="#">601000011</a>	0,242	1,452	12,2	29,7	2,2	16
<a href="#">601003509</a>	0,348	2,088	12,7	50,8	2	10
<a href="#">601003515*</a>	0,784	4,704	15	50,8	4,5	5
<a href="#">601003505</a>	0,233	1,398	16	40	1,5	10
<a href="#">601003506</a>	0,276	1,656	18	48	1,5	10
<a href="#">601003516</a>	0,987	5,922	25	55	4,6	6

(\*) Parede da cota 15mm possui espessura 7,5mm.

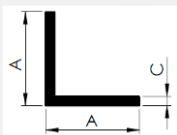

## CANTONEIRA ABAS IGUAIS

CÓDIGO	PESOS*		MILÍMETRO		POLEGADA		EMBALAGEM PADRÃO(BARRAS)
	kg/m	BARRA 6 m	A	C	A	C	
<a href="#">601000004</a>	0,053	0,318	12,7	0,7	1/2	-	30
<a href="#">601003511</a>	0,083	0,498	12,7	1,2	1/2	-	10
<a href="#">601002196</a>	0,062	0,372	15,87	0,7	5/8	-	30
<a href="#">601003513</a>	0,099	0,594	15,87	1,2	5/8	-	10
<a href="#">601002197</a>	0,075	0,450	19,05	0,7	3/4	-	30
<a href="#">601003512</a>	0,126	0,756	19,05	1,2	3/4	-	10
<a href="#">601003518</a>	0,283	1,698	22,22	2,38	7/8	3/32	10
<a href="#">601000185</a>	0,099	0,594	25,4	0,75	1	-	30
<a href="#">601003510</a>	0,169	1,014	25,4	1,2	1	-	10
<a href="#">601000019</a>	0,209	1,254	25,4	1,5	1	1/16	10
<a href="#">601002198</a>	0,430	2,580	25,4	3,17	1	1/8	10
<a href="#">601003504</a>	0,542	3,252	31,75	3,17	1.1/4	1/8	10
<a href="#">601000014</a>	0,585	3,510	38,10	3,17	1.1/2	1/8	8
<a href="#">601003508</a>	0,887	5,322	50,8	3,17	2	1/8	5
<a href="#">601000016</a>	1,303	7,860	50,8	4,76	2	3/16	4

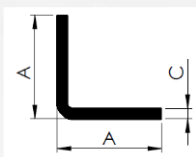

## CANTONEIRA ARREDONDADA ABAS IGUAIS

CÓDIGO	PESOS*		MILÍMETRO		POLEGADA		EMBALAGEM PADRÃO(BARRAS RAS)
	kg/m	BARRA 6 m	A	C	A	C	
601000007	0,049	0,294	12,70	0,7	1/2	-	30
601000008	0,053	0,318	15,87	0,7	5/8	-	30
601000009	0,064	0,384	19,05	0,7	3/4	-	30
601000010	0,085	0,510	25,4	0,7	1	-	30

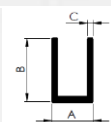

## PERFIL "U" ABAS DESIGUAIS

CÓDIGO	PESOS		MILÍMETRO			EMBALAGEM PADRÃO(BARRAS )
	kg/m	BARRA 6 m	A	B	C	
<u>601220002</u>	0,136**	0,822	25	12,7	1	30
<u>601220005</u>	0,137***	0,822	36	20,0	0,7	20
<u>601220001</u>	0,208**	1,248	50	12,7	1	10

(\*\*) Produtos utilizados geralmente para fachada de muro

(\*\*\*) Desempeno

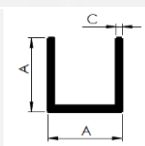

## PERFIL "U" ABAS IGUAIS

CÓDIGO	PESOS		MILÍMETRO			EMBALAGEM PADRÃO(BARRAS RAS)
	kg/m	BARRA 6 m	A	B	C	
601222200	0,068	0,408	9,52	-	1	20
601222199	0,095	0,570	12,7	-	1	20
601220003	0,286	1,716	12,7	-	1/8	10
601228715	0,148	0,888	15,87	-	1,3	20

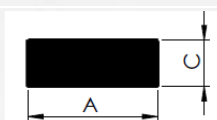

## BARRA CHATA

CÓDIGO	PESOS*		MILÍMETRO		POLEGADA		EMBALAGEM PADRÃO(BARRAS)
	kg/m	BARRA 6 m	A	C	A	C	
<a href="#">601090023</a>	0,064	0,384	12,7	2,00	1/2	-	50
<a href="#">601090713</a>	0,113	0,678	12,7	3,17	1/2	1/8	10
<a href="#">601090018</a>	0,228	1,368	12,7	6,35	1/2	1/4	15
<a href="#">601095091</a>	0,141	0,846	15,87	3,17	5/8	1/8	10
<a href="#">601092974</a>	0,213	1,278	15,87	4,76	5/8	3/16	10
<a href="#">601098041</a>	0,287	1,722	15,87	6,35	5/8	1/4	10
<a href="#">601090634</a>	0,173	1,038	19,05	3,17	3/4	1/8	10
<a href="#">601095092</a>	0,259	1,554	19,05	4,76	3/4	3/16	10
<a href="#">601095302</a>	0,342	2,052	19,05	6,35	3/4	1/4	10
<a href="#">601090014</a>	0,505	3,03	19,05	9,5	3/4	3/8	10
<a href="#">601090001</a>	0,200	1,200	22,22	3,17	7/8	1/8	10
<a href="#">601094936</a>	0,230	1,380	25,4	3,17	1	1/8	10
<a href="#">601090007</a>	0,286	1,716	31,75	3,17	1.1/4	1/8	10
<a href="#">601090631</a>	0,573	3,438	31,75	6,35	1.1/4	1/4	8
<a href="#">601090637</a>	0,859	5,154	31,75	9,52	1.1/4	3/8	5
<a href="#">601090017*</a>	0,872	5,232	31,75	9,52	1.1/4	3/8	5
<a href="#">601095094</a>	0,343	2,058	38,1	3,17	1.1/2	1/8	10
<a href="#">601090006</a>	0,514	3,084	38,1	4,76	1.1/2	3/16	10
<a href="#">601090004</a>	0,688	4,128	38,1	6,35	1.1/2	1/4	8
<a href="#">601090016</a>	1,017	6,102	38,1	9,5	1.1/2	3/8	5
<a href="#">601090019</a>	0,367	2,202	43,0	3,0	-	-	10
<a href="#">601090020</a>	0,409	2,454	48,0	3,0	-	-	10
<a href="#">601095095</a>	0,457	2,742	50,8	3,17	2	1/8	10
<a href="#">601097480</a>	0,689	4,134	50,8	4,76	2	3/16	5
<a href="#">601090002</a>	0,913	5,478	50,8	6,35	2	1/4	5
<a href="#">601098527</a>	1,148	6,888	50,8	7,93	2	5/16	5
<a href="#">601091510</a>	1,376	8,256	50,8	9,52	2	3/8	3
<a href="#">601090003</a>	1,835	11,010	50,8	12,7	2	1/2	3
<a href="#">601090013</a>	2,29	13,710	50,8	15,87	2	5/8	2
<a href="#">601098525</a>	0,573	3,438	63,5	3,17	2.1/2	1/8	5
<a href="#">601090008</a>	0,688	4,128	76,2	3,17	3	1/8	5
<a href="#">601090022</a>	1,306	7,836	76,2	6,34	3	1/4	4
<a href="#">601090025</a>	1,159	6,954	101,6	4,0	4	-	4
<a href="#">601090009</a>	1,368	8,208	101,6	4,76	4	3/16	3
<a href="#">601098526**</a>	1,446	7,230 (5m)	101,6	5	4	13/64	3
<a href="#">601090021**</a>	2,750	13,750 (5m)	101,6	9,52	4	3/8	2
<a href="#">601090024</a>	0,613	3.864	115	2	-	-	5

\*CANTO ARREDONDADO - \*\*BARRAS COM 5 METROS

## LINHA CIVIL

**CANTONEIRA  
SEXTAVADA ALTA**

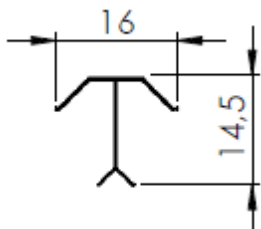

PESO 0,063 kg/m  
30 BARRAS POR PACOTE  
**60100001**

**CANTONEIRA  
REDONDA**

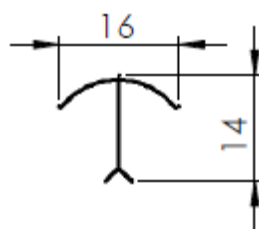

PESO 0,059 kg/m  
30 BARRAS POR PACOTE  
**60100002**

**RODAPÉ DE PAREDE**

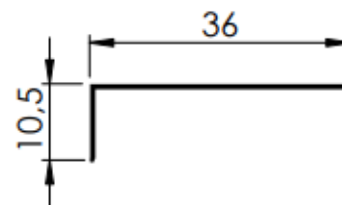

PESO 0,109 kg/m  
30 BARRAS POR PACOTE  
**601050001**

**CONTRA MARCO**

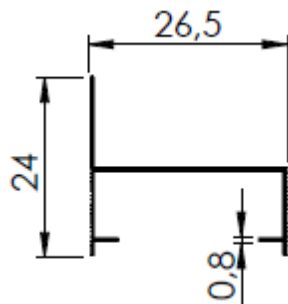

PESO 0,137 kg/m  
30 BARRAS POR PACOTE  
**601151554**

**CANTO DE ESCADA**

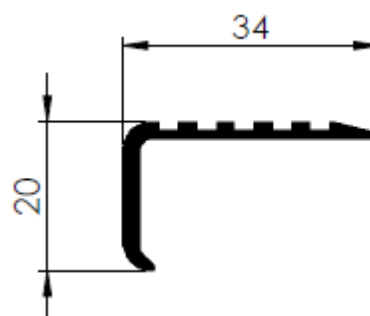

PESO 0,329 kg/m  
10 BARRAS POR PACOTE  
**601003507**

**CHAPA PASSADEIRA PARA  
CARPETE**

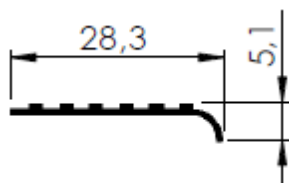

PESO 0,097 kg/m  
10 BARRAS POR PACOTE  
**601130003**

**“T” PARA FORROS**

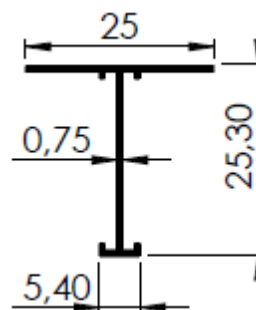

PESO 0,120 kg/m  
20 BARRAS POR PACOTE  
**601130004**

## LINHA CIVIL

### REGUA PRÁTICA - (SEM TAMPA)

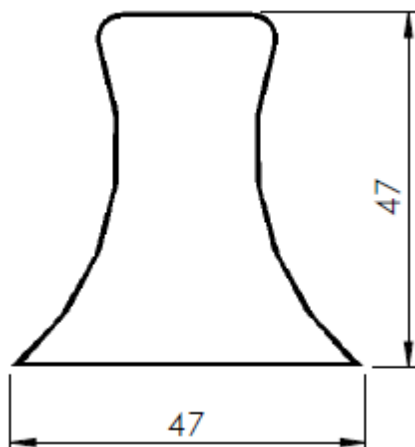

**600020010** - PESO 0,330 kg/m  
6 BARRAS POR PACOTE

### REGUA BITUBULAR 3 X 1 (TAMPA LARANJA)

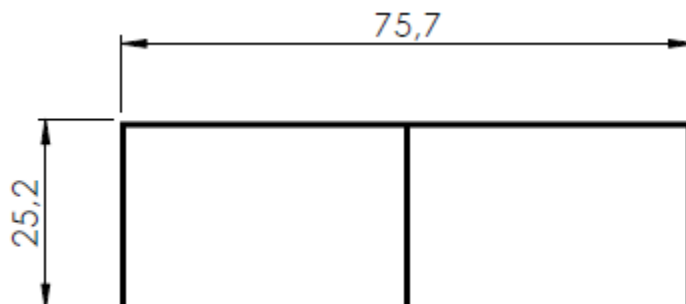

**600020002** - PESO 0,444 kg/m - 6 BARRAS POR PACOTE

**TEMOS TAMBÉM**

**601070005** - PESADA SEM TAMPA - LINHA MOVELERIA  
PESO 0,924 kg/m - 6 BARRAS POR PACOTE

### REGUA P/ DESEMPENO DE PISO 3" X 1.1/2" X 1,3MM (S/ TAMPA)

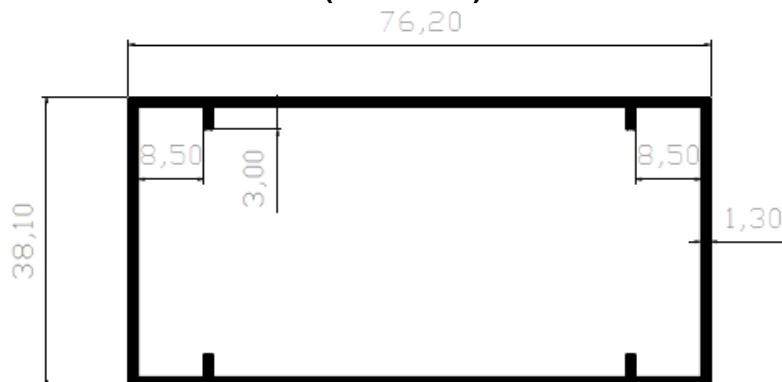

**600020015** - PESO 0,873 kg/m - 6 BARRAS POR PACOTE

### REGUA BITUBULAR "FINA" 2 X 1/2 (SEM TAMPA)

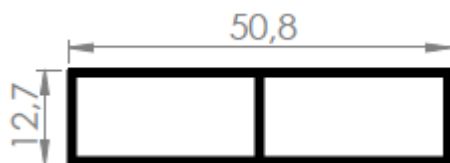

**600020003** - PESO 0,289 kg/m 6 BARRAS POR PACOTE

**TEMOS TAMBÉM**

**600020012** - PESADA SEM TAMPA - MOVELERIA  
PESO 0,382 kg/m 10 BARRAS POR PACOTE

### REGUA BITUBULAR "COMERCIAL" (TAMPA VERDE)

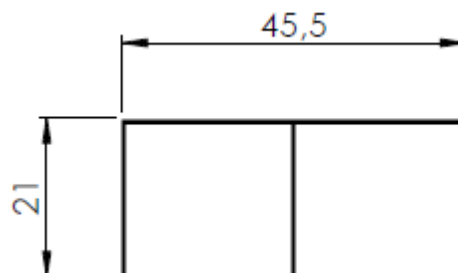

**600020006** - PESO 0,263 kg/m - 6 BARRAS POR PACOTE

## LINHA CIVIL

### REGUA BITUBULAR (TAMPA AZUL)

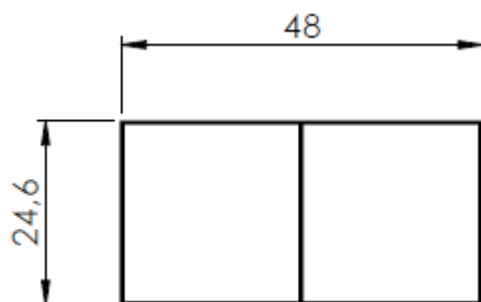

**600020001** - PESO 0,300 kg/m  
6 BARRAS POR PACOTE

### REGUA BIT. EXTRA COMERCIAL (TAMPA CINZA)

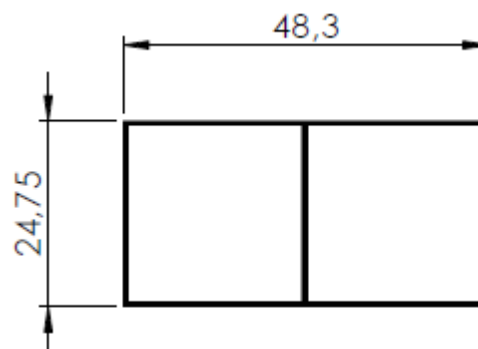

**600020011** - PESO 0,378 kg/m  
6 BARRAS POR PACOTE

### REGUA BIT. EXTRA (TAMPA VERMELHA)

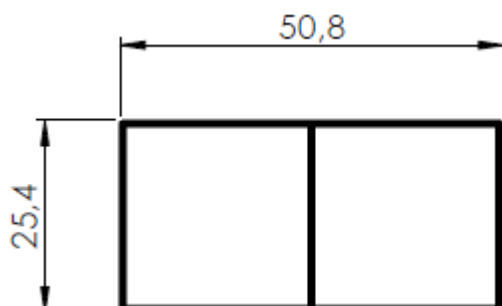

**600020004** - PESO 0,475 kg/m  
6 BARRAS POR PACOTE

### REGUA LISA (TAMPA BRANCA)



**600020014** - PESO 0,223 kg/m  
6 BARRAS POR PACOTE

### REGUA FRISADA (TAMPA AMARELA)

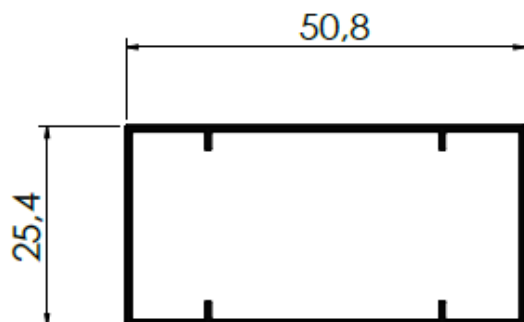

**600022288** - PESO 0,344 kg/m  
6 BARRAS POR PACOTE

### REGUA FRISADA EXTRA (TAMPA BORDÔ)

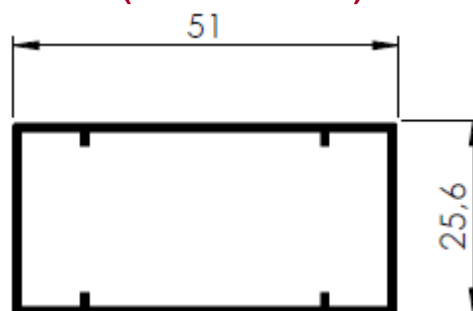

**600028203** - PESO 0,565 kg/m  
6 BARRAS POR PACOTE

## LINHA DOMESTICA

### TRILHO P/ CORTINA DUPLO

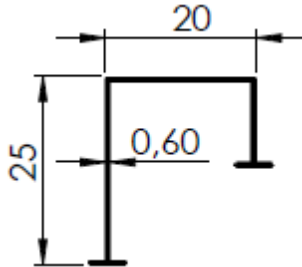

**601020001** - PESO 0,105 kg/m  
10 BARRAS POR PACOTE

### TRILHO P/ CORTINA DUPLO ESPECIAL

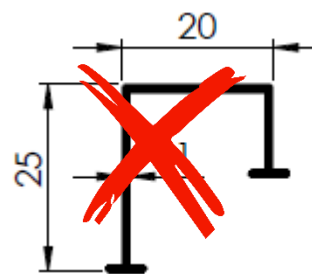

**601020004** - PESO 0,129 kg/m  
10 BARRAS POR PACOTE

### TRILHO P/ CORTINA TRIPLO

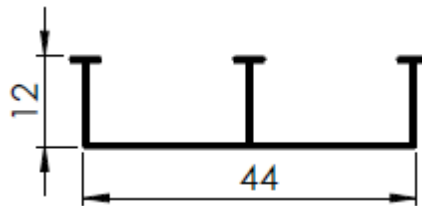

**601020002** - PESO 0,147 kg/m  
10 BARRAS POR PACOTE

### TRILHO SUIÇO MONO

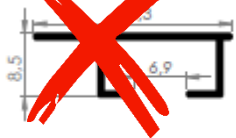

**601020005** - PESO 0,107 kg/m  
20 BARRAS POR PACOTE

### TRILHO SUIÇO DUPLO

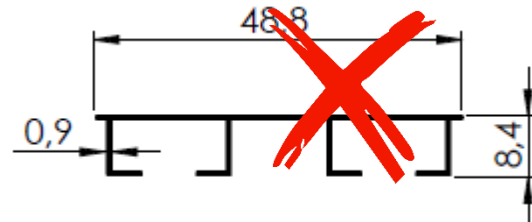

**601020006** - PESO 0,241 kg/m  
10 BARRAS POR PACOTE

### TRILHO SUIÇO TRIPLO

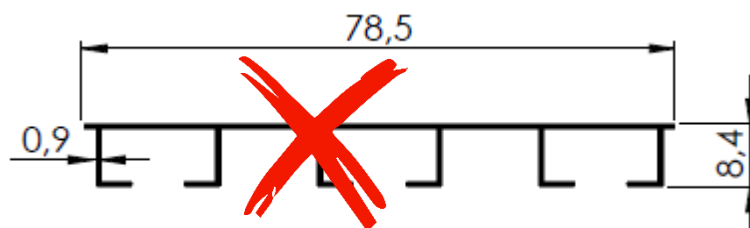

**601020007** - PESO 0,375 kg/m  
10 BARRAS POR PACOTE

## LINHA DOMESTICA

### TRILHO SUIÇO MONO C/ BANDÔ

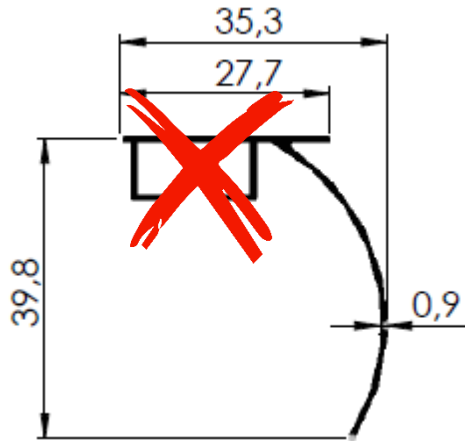

**601020008** - PESO 0,244kg/m  
10 BARRAS POR PACOTE

### TRILHO SUIÇO DUPLO C/ BANDÔ

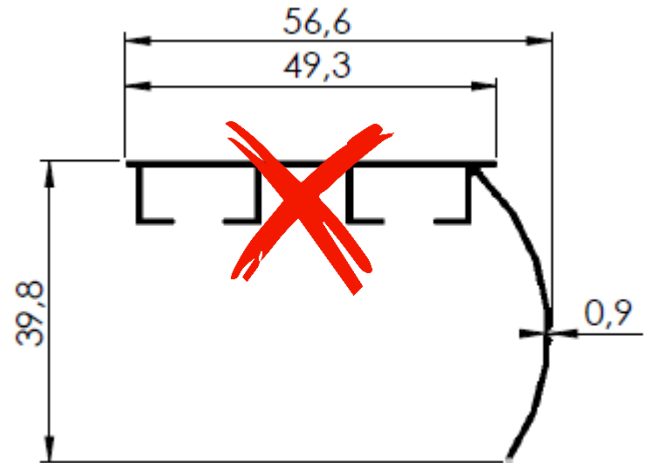

**601020009** PESO 0,355 kg/m - 10 BARRAS POR PACOTE

## ESCADA

### DEGRAU TUBULAR

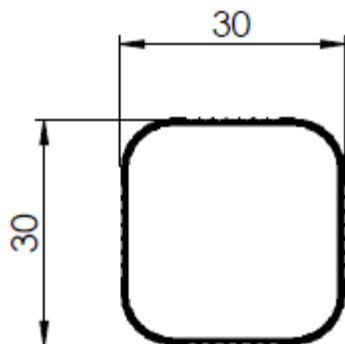

**601130025** - PESO 0,330 kg/m  
10 BARRAS POR PACOTE

### DEGRAU RETANGULAR

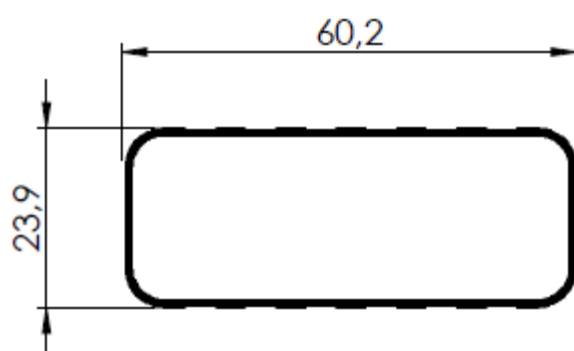

**601130024** - PESO 0,541 kg/m - 10 BARRAS POR PACOTE

### DEGRAU REDONDO

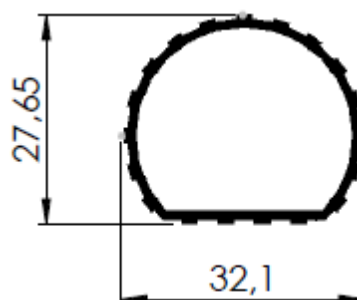

**601130023** - PESO 0,376 kg/m - 10 BARRAS POR PACOTE

# BARCO

## BORDA NORMAL

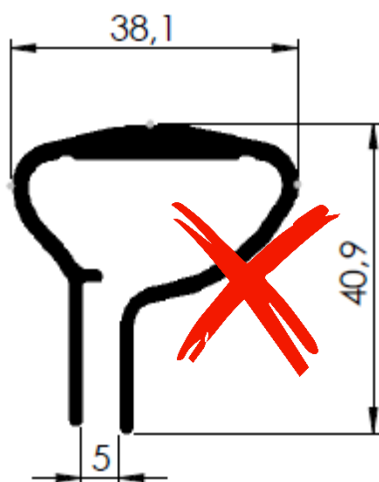

**601280001** - PESO 0,906 kg/m  
6 BARRAS POR PACOTE

## BORDA LEVE

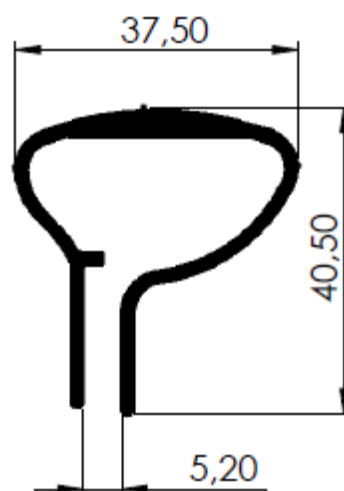

**601280005** - PESO 0,669 kg/m  
8 BARRAS POR PACOTE

## FLUTUANTE

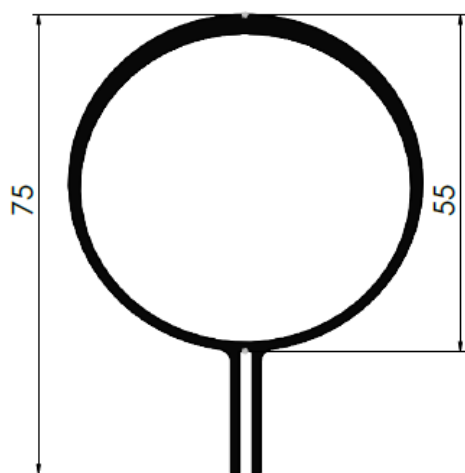

**601280011** - PESO 1,209 kg/m  
4 BARRAS POR PACOTE

## PERFIL "T"

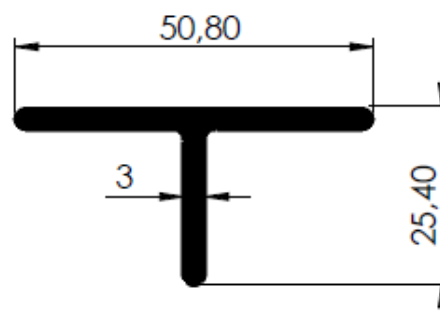

**601280003** - PESO 0,638 kg/m  
9 BARRAS POR PACOTE

# BARCO

**TRAPÉZIO LEVE**

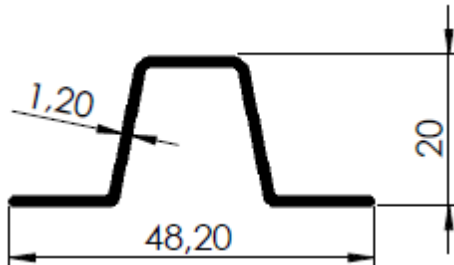

**601280004** - PESO 0,265 kg/m  
20 BARRAS POR PACOTE

**TRAPÉZIO NORMAL**

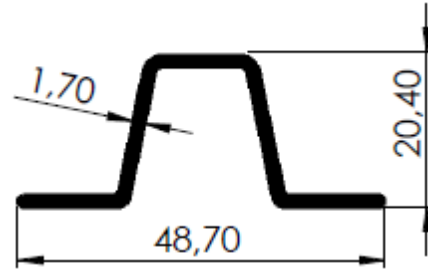

**601280002** - PESO 0,375 kg/m  
12 BARRAS POR PACOTE

**TRAPÉZIO NOVO**



**601280008** - PESO 0,305 kg/m  
20 BARRAS POR PACOTE

**TRAPÉZIO 4**

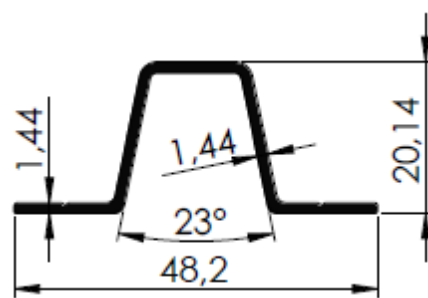

**601280009** - PESO 0,316 kg/m  
20 BARRAS POR PACOTE

**TRAPÉZIO 61 X 32,5**

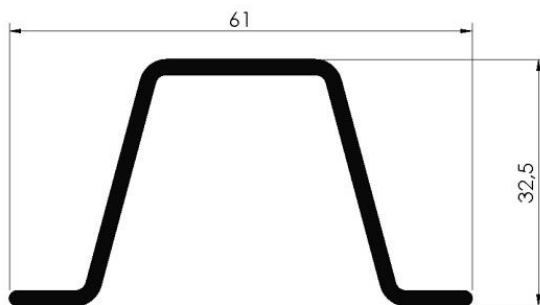

**601280015** - PESO 0,596 kg/m  
6 BARRAS POR PACOTE

**QUILHA**

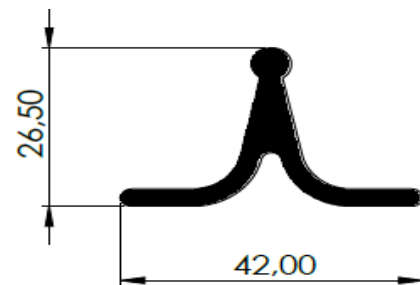

**601280021** - PESO 0,627 kg/m  
8 BARRAS POR PACOTE

# ARO PARA BICICLETA

## BIVALENTE

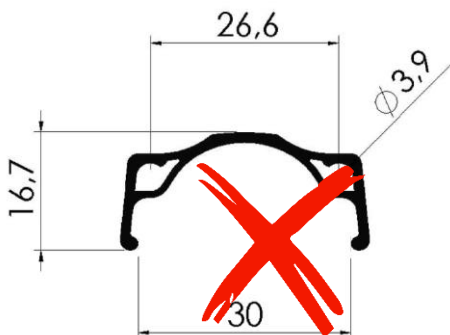

**601138553** - PESO 0,304 kg/m

20 BARRAS POR PACOTE

## AERO ENDURO II

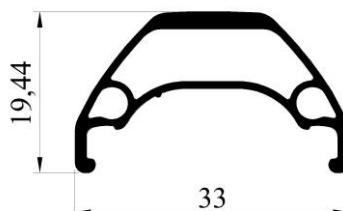

**601130140** - PESO 0,330 kg/m

15 BARRAS POR PACOTE

## AERO

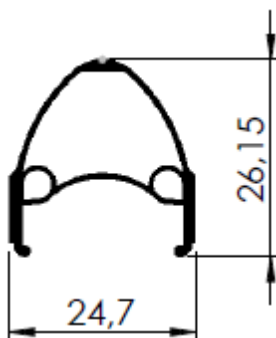

**601130862** - PESO 0,283 kg/m

20 BARRAS POR PACOTE

## AERO MAXIMUM

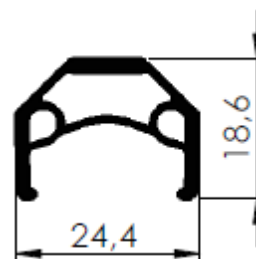

**601130011** - PESO 0,293 kg/m

20 BARRAS POR PACOTE

## AEREO TUBELESS

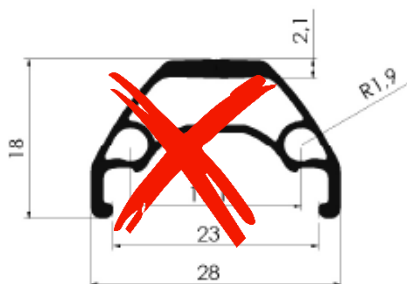

**601130123** - PESO 0,292 kg/m

20 BARRAS POR PACOTE

## VEMAX II

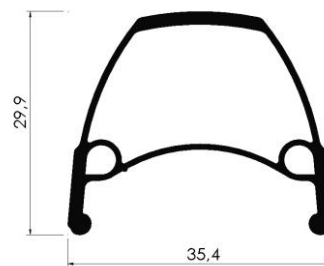

**601130122** - PESO 0,404kg/m

15 BARRAS POR PACOTE

## ARO PARA BICICLETA

### CONVENCIONAL LEVE

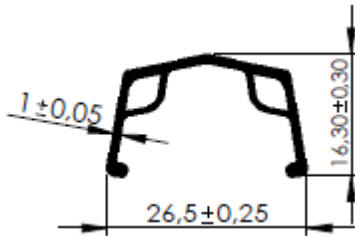

**601130872** - PESO 0,198 kg/m  
20 BARRAS POR PACOTE

### CONVENCIONAL REFORÇADO

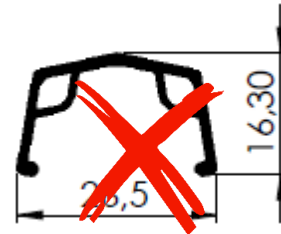

**601138672** PESO 0,231 kg/m  
20 BARRAS POR PACOTE

### CONVENCIONAL MAX

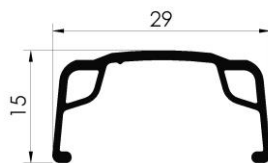

**601130105** - PESO 0,207 kg/m  
20 BARRAS POR PACOTE

### BARRA FORTE REFORÇADO

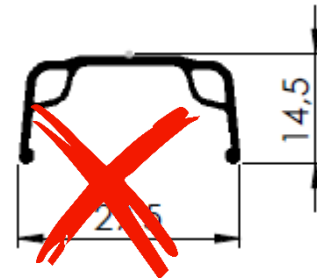

**601130861** - PESO 0,235 kg/m  
20 BARRAS POR PACOTE

## CAMINHÃO – TRILHOS PARA CABINES

### TRILHO I ESPECIAL

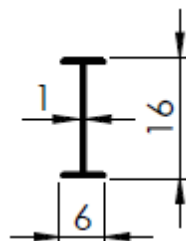

**600030003**- PESO 0,075 kg/m  
5 ROLOS (5,5m OU 7m) POR PACOTE  
20 BRS PACOTE P/ 6M (300 QUILOS)

### TRILHO C

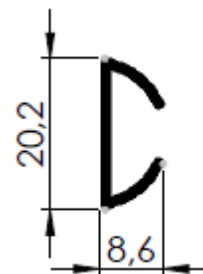

**600030002** PESO 0,168 kg/m  
0,355 kg BARRA 2,05 m  
6 BARRAS POR PACOTE

## CAMINHÃO – PROTEÇÃO LATERAL

### ARREMATE TRASEIRO COMERCIAL

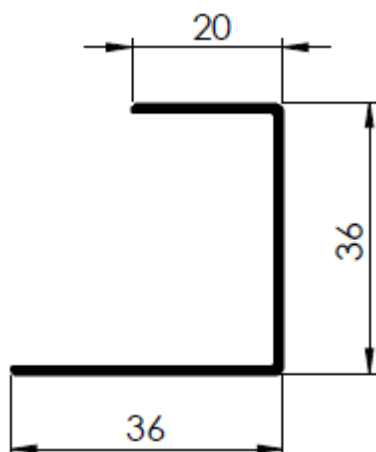

**601271005** - PESO 0,378 kg/m  
3 BARRAS POR PACOTE

### ARREMATE TRASEIRO COMERCIAL (NOVO)

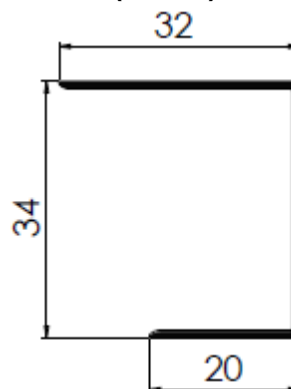

**601270005** - PESO 0,249 kg/m  
3 BARRAS POR PACOTE

### ARREMATE DIANTEIRO COMERCIAL

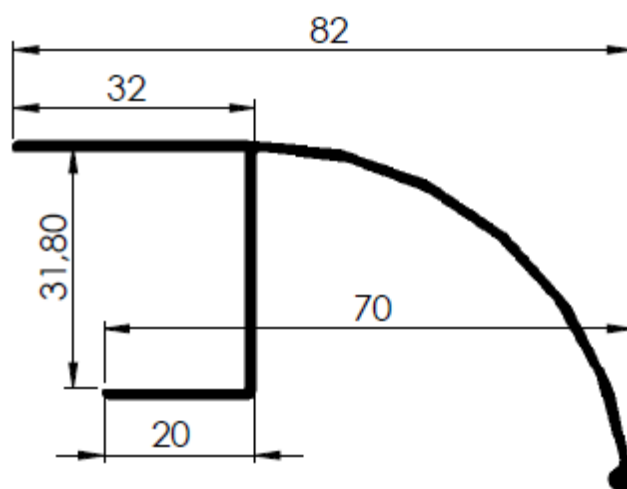

**601271006** PESO 0,506 kg/m- 3 BARRAS POR PACOTE

## CAMINHÃO – PROTEÇÃO LATERAL

TRAVESSA LATERAL "COMERCIAL III"

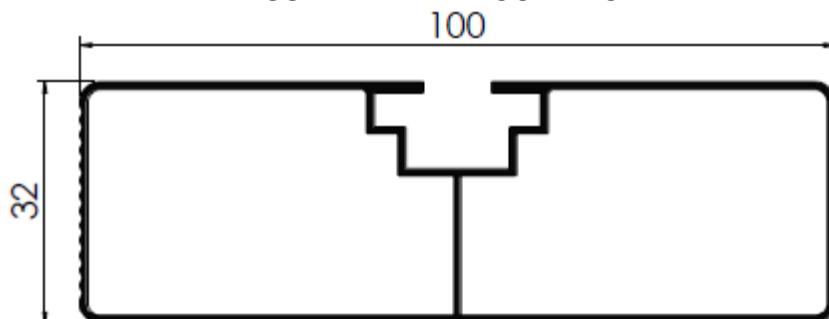

601270004 - PESO 0,837 kg/m - 3 BARRAS POR PACOTE

TRAVESSA LATERAL COMERCIAL VI

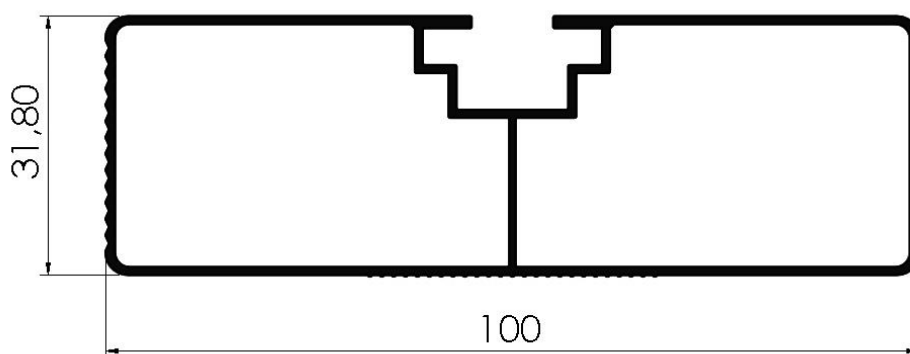

601270025 - PESO 0,837 kg/m3 BARRAS POR PACOTE

ARREMATE DIANTEIRO COMERCIAL (NOVO)

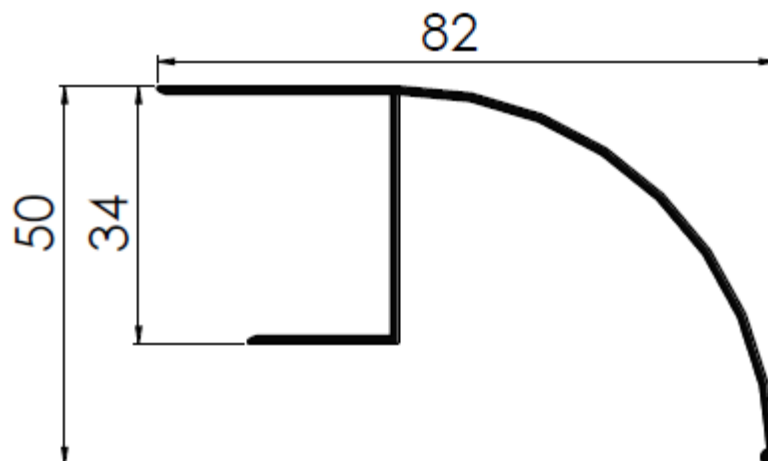

601270006 PESO 0,484 kg/m- 3 BARRAS POR PACOTE

## CAMINHÃO – PROTEÇÃO LATERAL

**TRAVESSA LATERAL "COMERCIAL IV"**

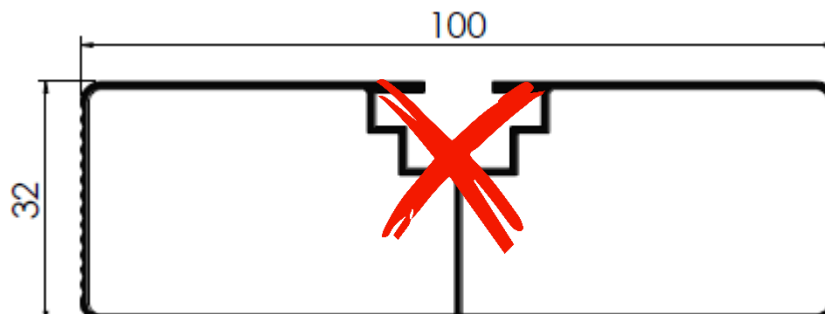

**601270015** - PESO 0,966 kg/m - 3 BARRAS POR PACOTE

**TRAVESSA LATERAL V**

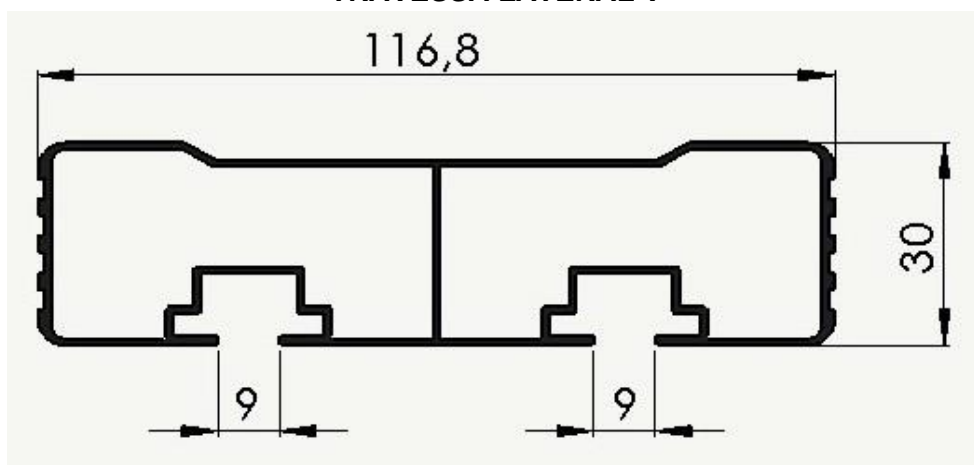

**601270022** - PESO 1,179 kg/m - 3 BARRAS POR PACOTE

**TRAVESSA LATERAL "COMERCIAL II"**

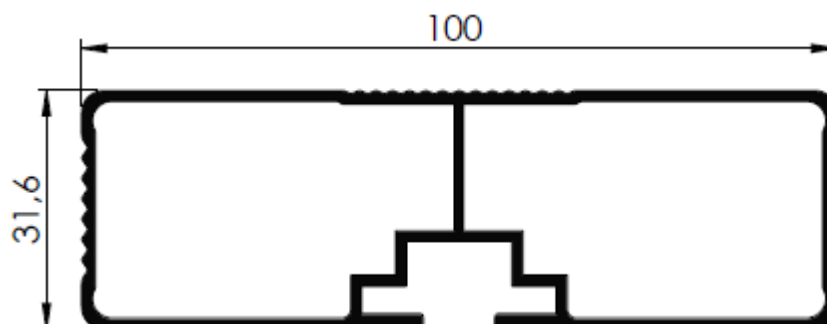

**601270002** - PESO 1,198kg/m - 3 BARRAS POR PACOTE

## CAMINHÃO – PROTEÇÃO LATERAL

TRAVESSA LATERAL VII

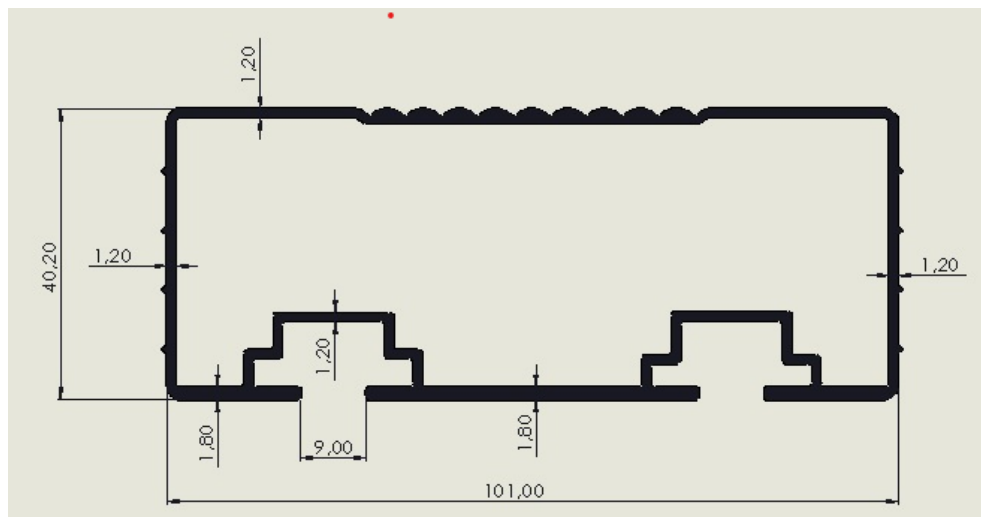

601270027 - PESO 1,273 kg/m- 3 BARRAS POR PACOTE

TRAVESSA LATERAL VIII

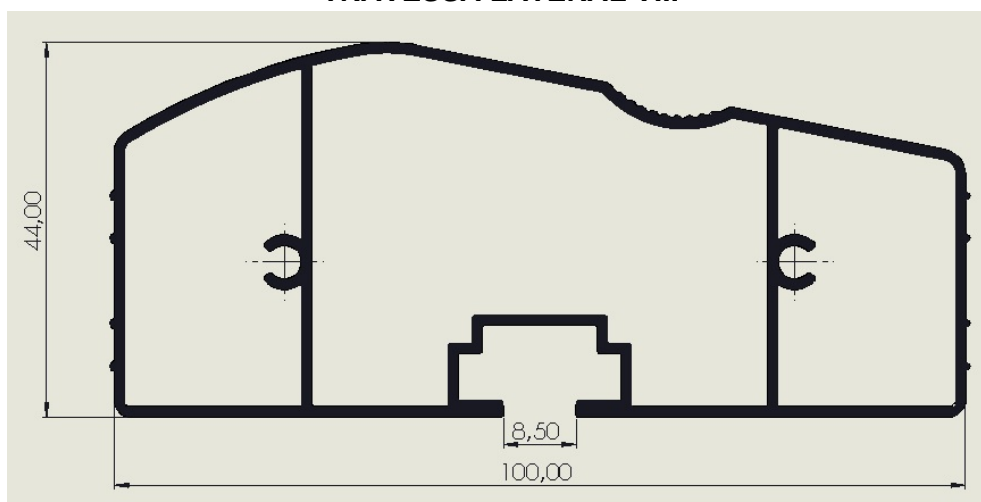

601270028 - PESO 1,195 kg/m- 3 BARRAS POR PACOTE

TRAVESSA LATERAL T-3687

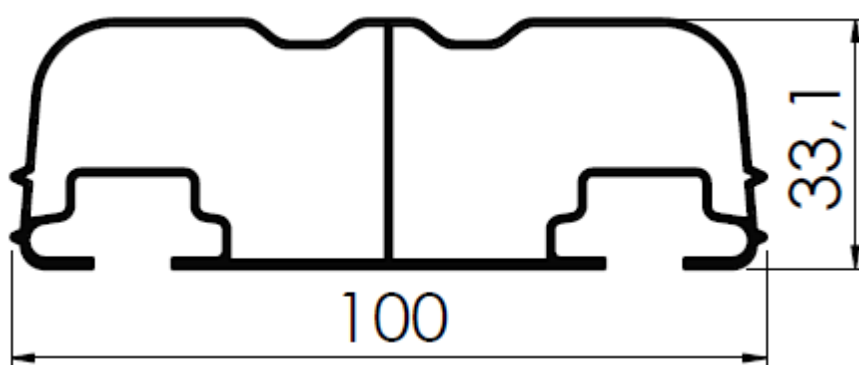

601270008 - PESO 0,943 kg/m- 3 BARRAS POR PACOTE

## CAMINHÃO – PROTEÇÃO LATERAL

### TRAVESSA LATERAL COMERCIAL

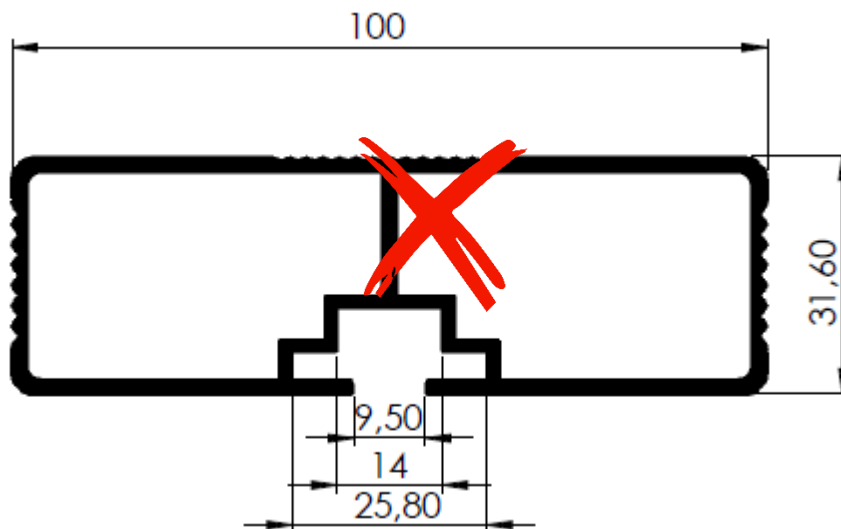

**601271004** - PESO 1,598 kg/m<sup>3</sup> BARRAS POR PACOTE

### TRAVESSA LATERAL IX

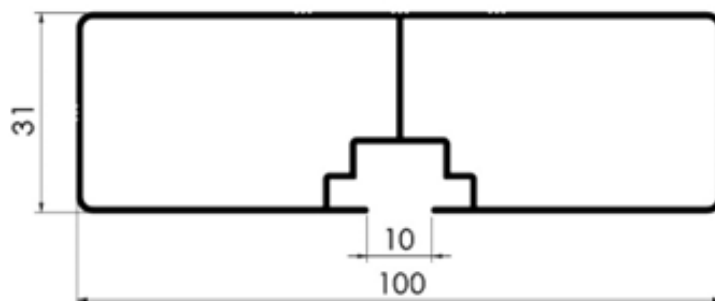

**601270032** - PESO 0,689/m<sup>3</sup> BARRAS POR PACOTE

### PROTETOR LATERAL BOIADEIRA

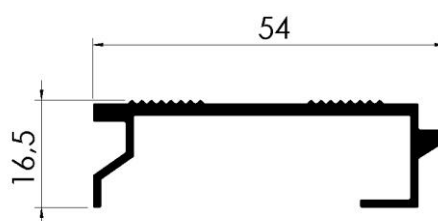

**601270023** PESO 0,480 kg/m- 3 BARRAS POR PACOTE

## CAMINHÃO – DIVERSOS

ESTICADOR DE LONA SIDER MODELO FC

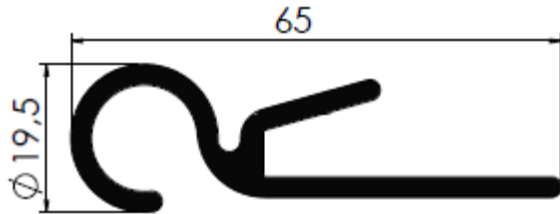

601270012 - PESO 0,712 kg/m  
4 BARRAS POR PACOTE

ESTICADOR DE LONA SIDER MODELO RD

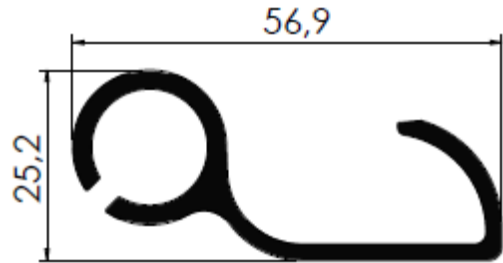

601270007 - PESO 0,830 kg/m  
6 BARRAS POR PACOTE

ENROLADOR LONA SIDER



601270011 - PESO 1,122 kg/m  
3 BARRAS POR PACOTE  
**LOTE MÍNIMO: 200 QUILOS**

ENROLADOR LONA SIDER II

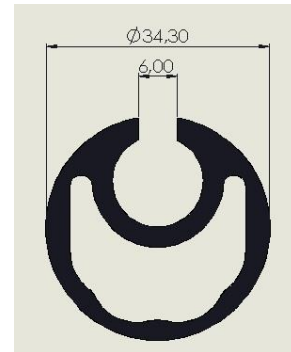

601270011 - PESO 1,095 kg/m  
3 BARRAS POR PACOTE

**CANTONEIRA L BAU  
4X2X2,8MM**

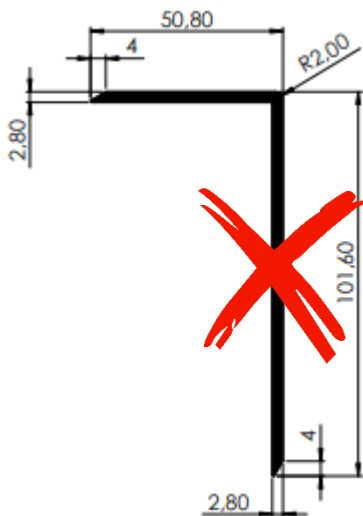

601270029 - PESO 1,116 kg/m  
3 BARRAS POR PACOTE

PERFIL "J" BAÚ II  
(PINGADEIRA)



601270021 - PESO 0,134 kg/m  
10 BARRAS POR PACOTE

PERFIL "J" BAÚ  
(PINGADEIRA)



601270013 - PESO 0,128 kg/m  
10 BARRAS POR PACOTE

PERFIL "J" BAÚ III  
(PINGADEIRA)

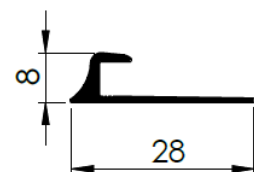

601270024 - PESO 0,117 kg/m  
10 BARRAS POR PACOTE

# CAMINHÃO – DIVERSOS

## CANTONEIRA BAU III

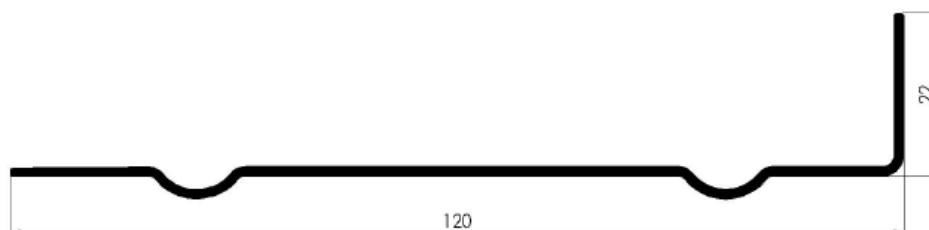

601270019 - PESO 0,565 kg/m  
6 BARRAS POR PACOTE

## CANTONEIRA BAU II

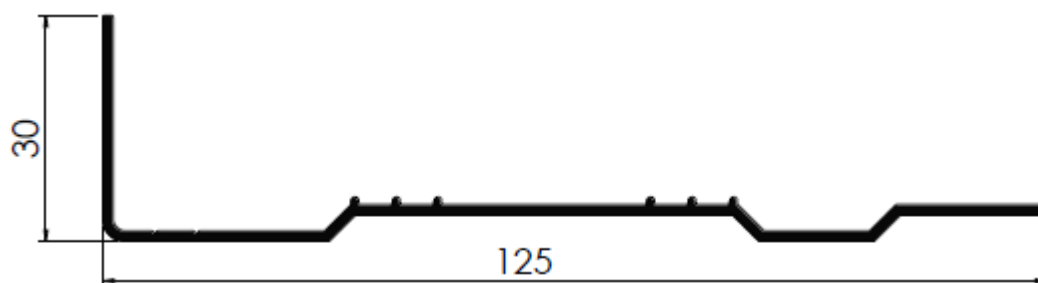

601270014 - PESO 0,639 kg/m  
4 BARRAS POR PACOTE

## CANTONEIRA BAU (BARRANQUEIRA)

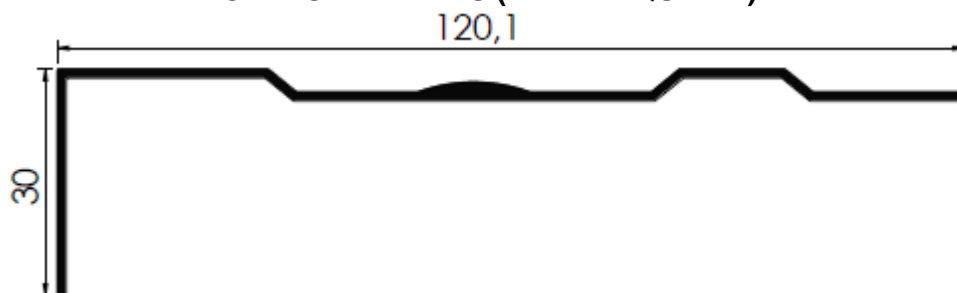

601270009 - PESO 0,528 kg/m  
4 BARRAS POR PACOTE

## GUIA PARA PALET

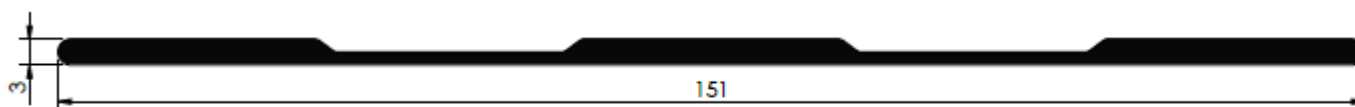

601270020 - PESO 0,970 kg/m  
3 BARRAS POR PACOTE

## CAMINHÃO – DIVERSOS

GANCHEIRA PARA FURGÃO FIGRORÍFICO

149,50



**601270010** - PESO 7,930 kg/m

1 BARRAS COM 1,5 POR PACOTE

**DISPONIBILIZAMOS PEÇAS ACABADAS COM 60MM - USINADAS E POLIDAS - CAIXA COM 12 UNIDADES**

BATENTE PARA FURGÃO

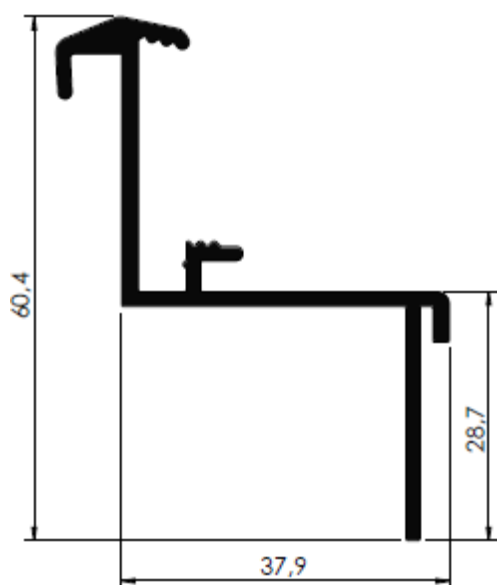

**601270016** - PESO 7,930 kg/m

6 BARRASPOR PACOTE

ANTIDERRAPANTE P/ PARA-CHOQUE

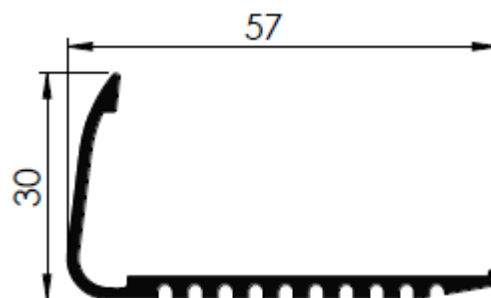

**601270003** - PESO 0,421 kg/m

10 BARRAS POR PACOTE

## CAMINHÃO – DIVERSOS

**CANTONEIRA 85X45X1,4MM**

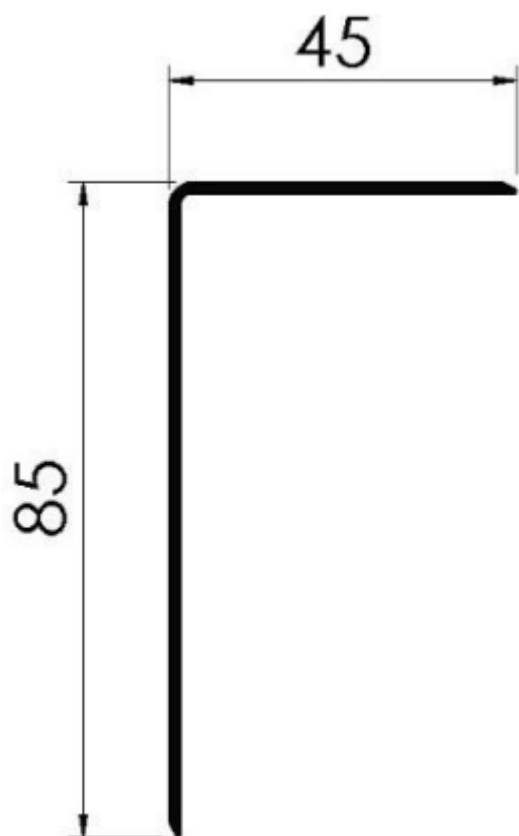

**601000022** - PESO 0,507 kg/m  
3 BARRAS POR PACOTE

**CONTORNO DE PORTA GRANDE  
66,80 X 48,3 X 35,2MM**

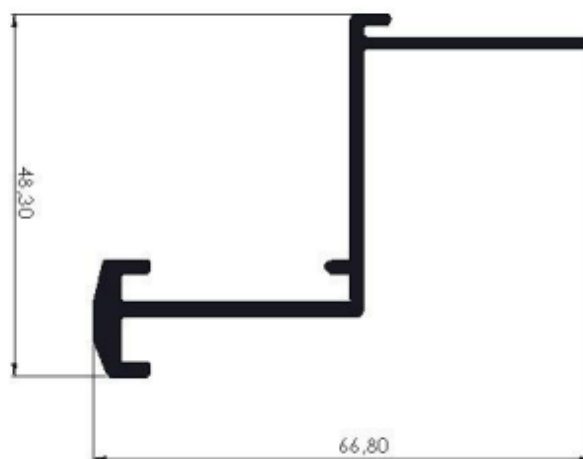

**6011270031** - PESO 0,632 kg/m  
3 BARRAS POR PACOTE

**PERFIL CARTOLA PARA CAMINHAO  
89,60 X 34,50MM**

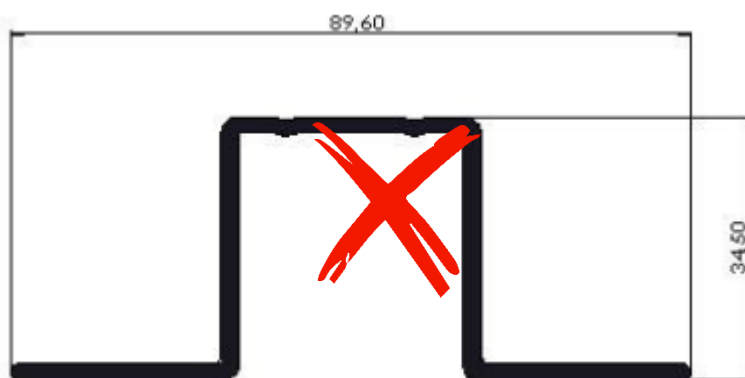

**601270030** - PESO 0,834 kg/m  
3 BARRAS POR PACOTE

## CAMINHÃO – TIRA FINA

**TRITUB. COM. NOVA\***



**600050004** - PESO 0,263 kg/m  
10 BARRAS POR PACOTE

**OBLONGA TRITUB. COM. NOVA\***

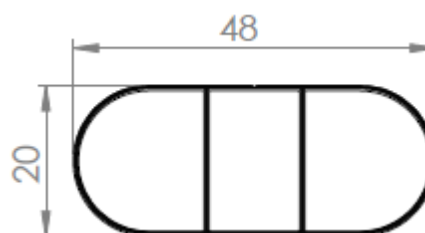

**600050005** - PESO 0,296 kg/m  
10 BARRAS POR PACOTE

**TRITUB. COM CAVAS EXTRA**

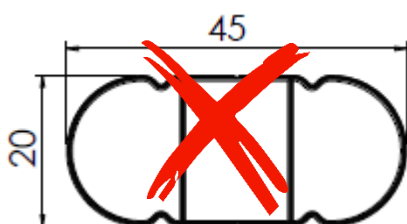

**600050006** - PESO 0,320 kg/m  
10 BARRAS POR PACOTE

**TRITUB. COM CAVAS NOVA\***

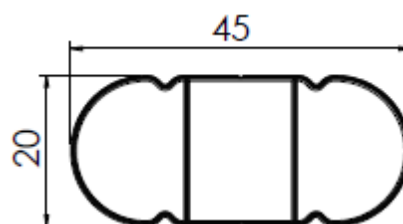

**600050008** - PESO 0,280 kg/m  
10 BARRAS POR PACOTE

(\*) **COMERCIALIZAMOS A TAMPA PLÁSTICA PARA ESTE MODELO**

## LINHA FOTOVOLTAÍCO

### ESTRUTURAL FOTOVOLTAICO

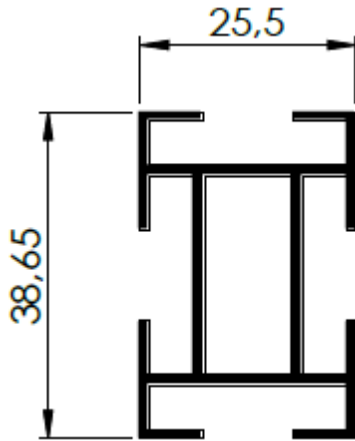

**601260021** - PESO 0,600 kg/m  
8 BARRAS POR PACOTE

### PRESILHA DE FIXAÇÃO PAINEL SOLAR

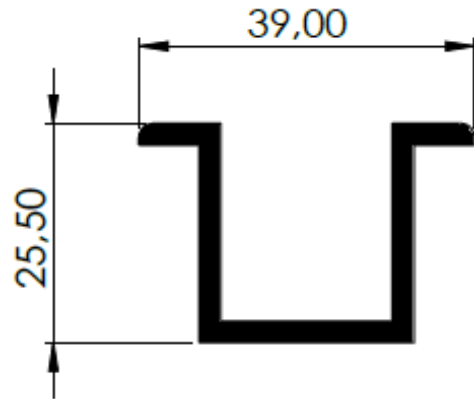

**601260022** - PESO 0,600 kg/m  
8 BARRAS POR PACOTE

### PERFIL FOTOVOLTAICO NH-021

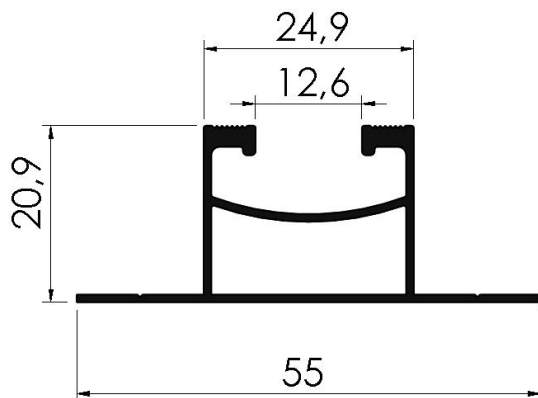

**601260023** - PESO 0,383 kg/m  
10 BARRAS POR PACOTE

### PERFIL FOTOVOLTAICO NH-022

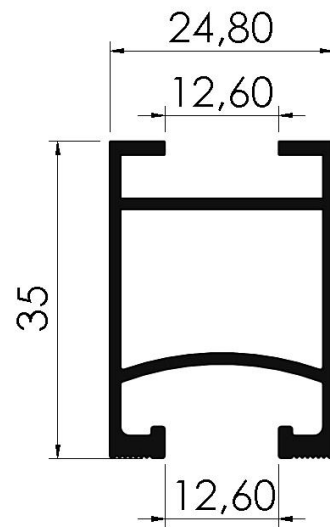

**601260024** - PESO 0,510 kg/m  
8 BARRAS POR PACOTE

### TERMINAL DE PLACA SOLAR

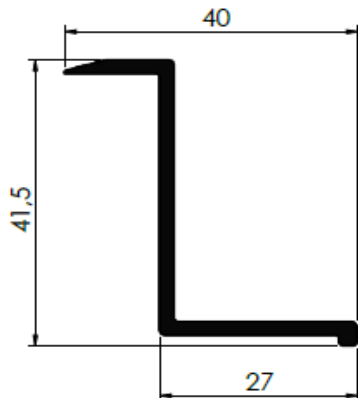

**601260017** - PESO 0,441 kg/m  
12 BARRAS POR PACOTE

## LINHA CASE

**CASE 01 31,4 X13,9MM**

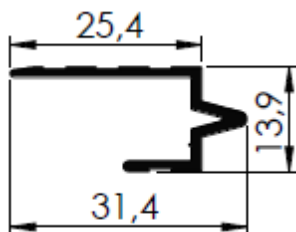

**601130073** PESO 0,198 kg/m  
30 BARRAS POR PACOTE

**CASE 02 25,4 X13,9MM**

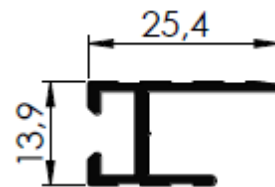

**601130074** - PESO 0,221 kg/m  
20 BARRAS POR PACOTE

**CASE 03 18,9 X18,9MM**

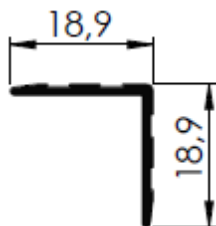

**601130075** - PESO 0,123 kg/m  
40 BARRAS POR PACOTE

**CASE 04 25,4 X25,4MM**

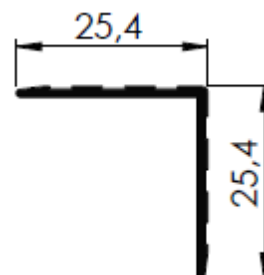

**601130076** - PESO 0,167 kg/m  
30 BARRAS POR PACOTE

**CASE 05 22,5 X18,8MM**

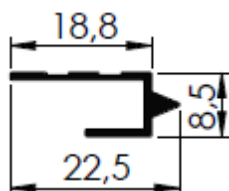

**601130080** - PESO 0,112 kg/m  
40 BARRAS POR PACOTE

**CASE 06 17,9 X12,4MM**

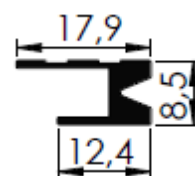

**601130081** - PESO 0,155 kg/m  
30 BARRAS POR PACOTE

# MOVELEIRA

**OBLONGO 37,7x15,5 x1,0MM**

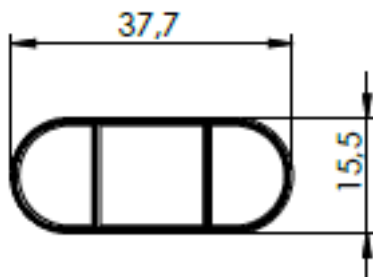

**601080014**-PESO 0,334 kg/m  
10 BARRAS POR PACOTE

**OBLONGO 38,7x15,5x1,0MM**

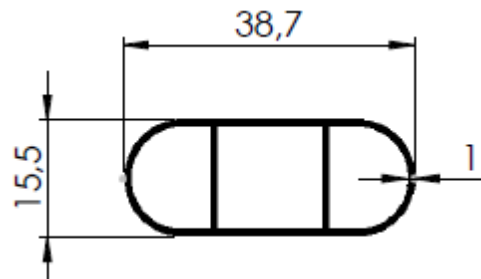

**601080002**-PESO 0,326 kg/m  
10 BARRAS POR PACOTE

**OBLONGO 38,7 x 15,5 x 1,05MM**

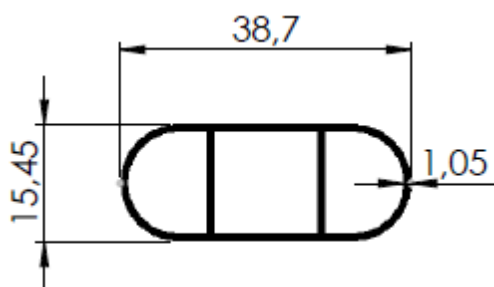

**601088784** - PESO 0,351 kg/m  
10 BARRAS POR PACOTE

**OBLONGO 38,7 x 15,5 x 1,2MM**

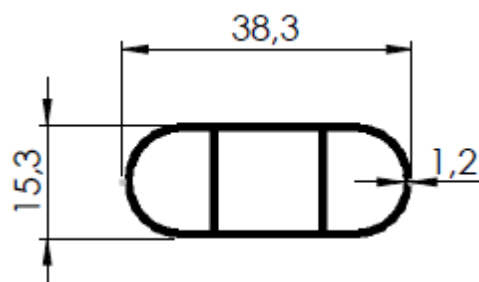

**601088782** - PESO 0,396 kg/m  
10 BARRAS POR PACOTE

**OBLONGO 38,7 x 15,5 x 1,6MM**

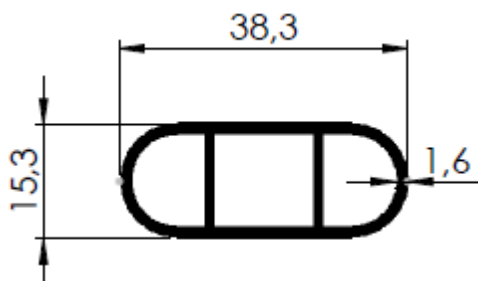

**601082910** - PESO 0,494 kg/m  
10 BARRAS POR PACOTE

**OBLONGO 49,8 x 15 x 1,15MM**

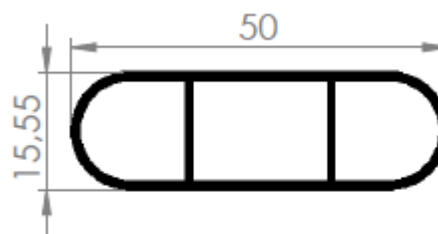

**601080009** - PESO 0,442 kg/m  
10 BARRAS POR PACOTE

# MOVELEIRA

**OBLONGO 50 x 15 x 1,4 X 1,4MM**

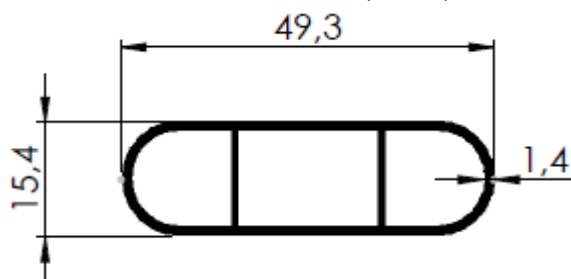

**601088785** - PESO 0,514 kg/m  
10 BARRAS POR PACOTE

**TRAV. BITULAR 60 x 7 x 1,2MM**

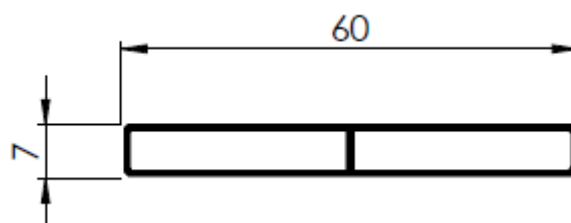

**601071591** - PESO 0,384 kg/m  
10 BARRAS POR PACOTE

**TRAVA TELA 25 X 20 X 1,5MM**

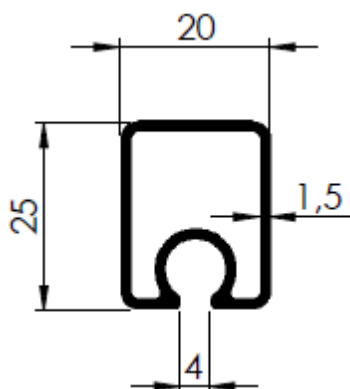

**601140521** PESO 0,430 kg/m  
10 BARRAS POR PACOTE

**ELIPTICO 35X20X 1,3MM C/ ALMA**

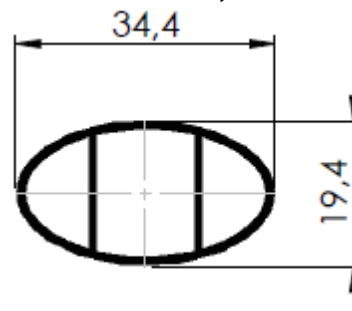

**601110006** - PESO 0,388 kg/m  
10 BARRAS POR PACOTE

**ELIPTICO 45X20X1,6MM C/ ALMA**

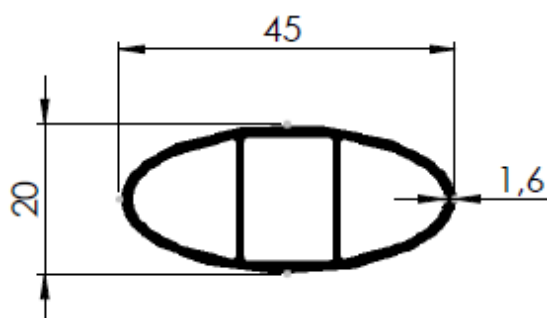

**601110005** PESO 0,544 kg/m  
10 BARRAS POR PACOTE

**OBLONGO C/ ABA 49 X 17 X 11,4MM**

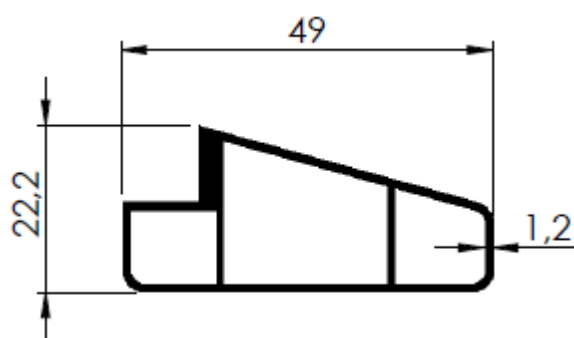

**601080001** - PESO 0,546 kg/m  
10 BARRAS POR PACOTE

# MOVELEIRA

**TRAV. BITUBULAR 42 X 18 X 1,2MM**

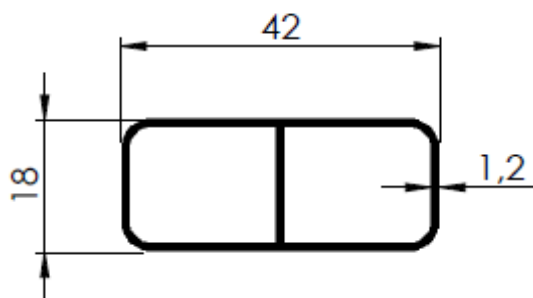

**601071592** - PESO 0,415 kg/m  
10 BARRAS POR PACOTE

**TRAV. BITUBULAR 42 X 18 X 1,7MM**

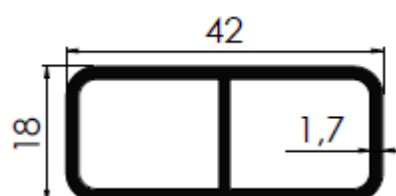

**601070011** - PESO 0,579 kg/m  
10 BARRAS POR PACOTE

**TRAV. TRITUBULAR 38 X 16,50**

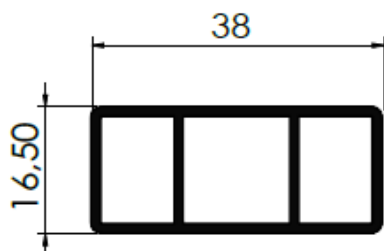

**601070015** - PESO 0,473 kg/m  
10 BARRAS POR PACOTE

**TRAVESSA 49,8 X 14 X 1,2MM**

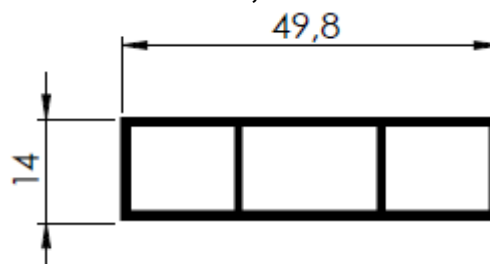

**601138673** - PESO 0,498 kg/m  
10 BARRAS POR PACOTE

**TRAV. TRITUBULAR C/ FRISO EXT.**  
**42,4 X 18,0 X 0,94MM**

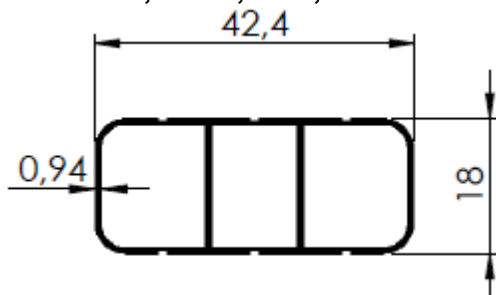

**600051109** - PESO 0,378 kg/m  
10 BARRAS POR PACOTE

**TUBO RETANG. 40X15X1,3MM**

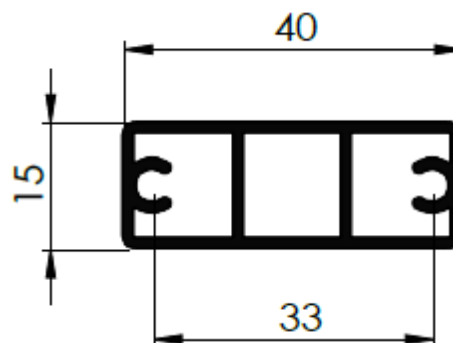

**601070010** - PESO 0,545 kg/m  
8 BARRAS POR PACOTE

# MOVELEIRA

## TRAV. TRITUBULAR 35X16,8X1,6MM

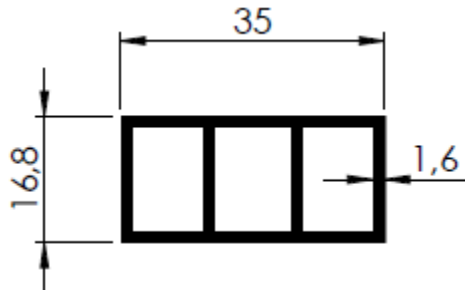

**601131557** - PESO 0,567 kg/m  
10 BARRAS POR PACOTE

## TUBO RETANGULAR 40X20X2MM

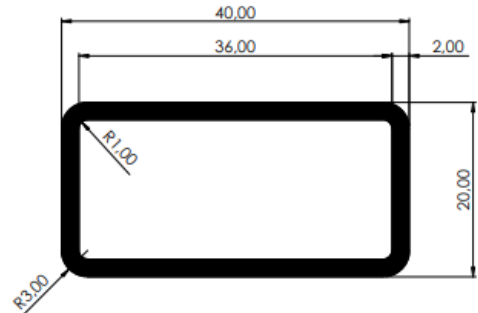

**601070018** - PESO 0,619 kg/m  
6 BARRAS POR PACOTE

## TRAV. TRITUBULAR 42,4X18,0X1,6MM

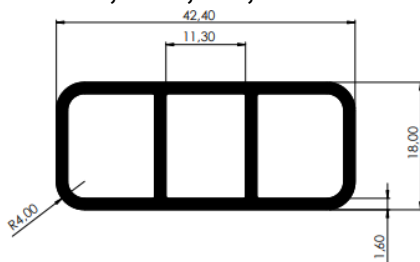

**601070017** - PESO 0,630 kg/m  
30 BARRAS POR PACOTE

## PERFIL BITUBULAR "REGUA FINA"

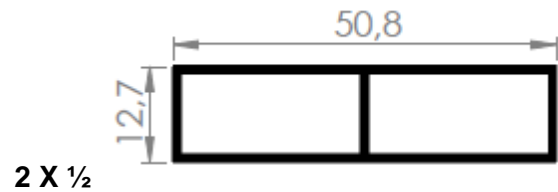

**600020012** - PESADA SEM TAMPA - LINHA  
MOVELERIA PESO 0,382 kg/m 10 BARRAS POR PACOTE

## PERFIL P/ TELA MOSQUITEIRA

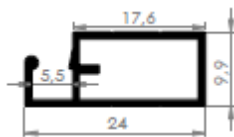

**601130043** - PESO 0,182 kg/m  
30 BARRAS POR PACOTE

## PERFIL BITUBULAR 3 X 1

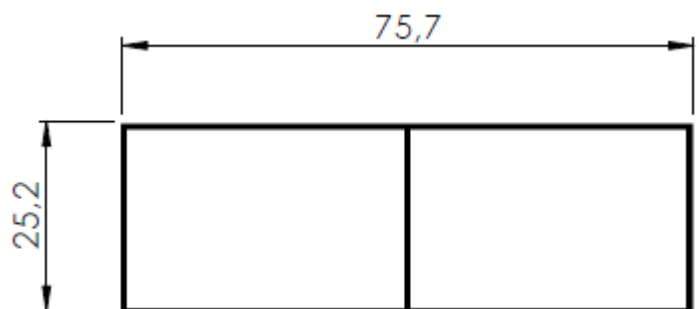

**601070005** - PESADA SEM TAMPA - LINHA MOVELERIA  
PESO 0,924 kg/m - 6 BARRAS POR PACOTE

# MOVELEIRA

## TUBO QUADRADO PENTATUBULAR

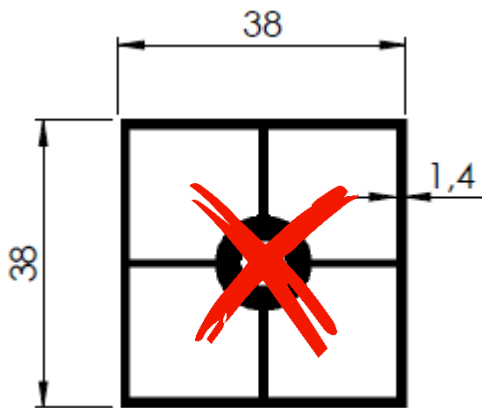

**601140001** - PESO 1,022 kg/m  
6 BARRAS POR PACOTE

## TUBO REDONDO 38,10 COM OLHAL

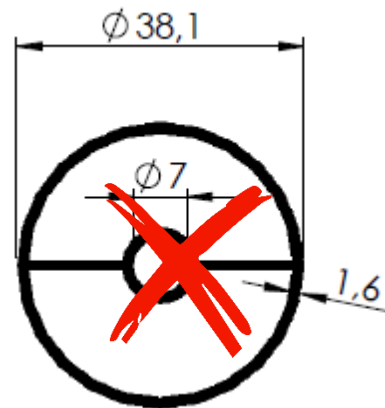

**601140004** - PESO 0,735 kg/m  
6 BARRAS POR PACOTE

## TUBO QUAD. 3/4" X 1MM C/ OLHAL

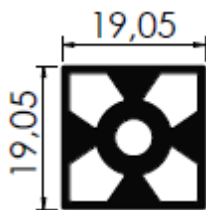

**601140027** - PESO 0,558 kg/m  
8 BARRAS POR PACOTE

## TUBO RETANGULAR (FRISO INTERNO) 50,8 X 38,1 X 0,95

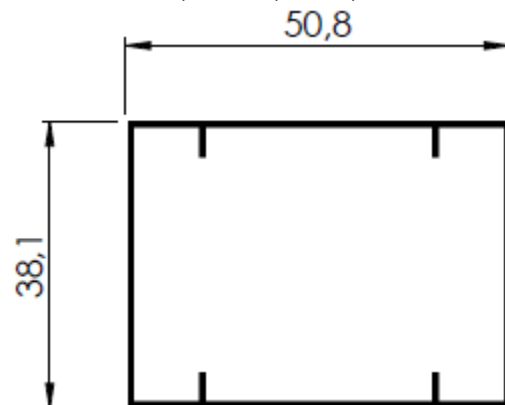

**601070015**  
- PESO 0,530 kg/m

## PERFIL LATERAL MESA 30 X 12,5 MM

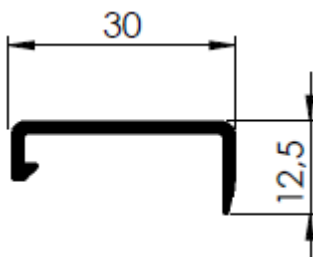

**601130016** - PESO 0,273 kg/m  
20 BARRAS POR PACOTE

## PERFIL LATERAL MESA 39 X 14,5MM

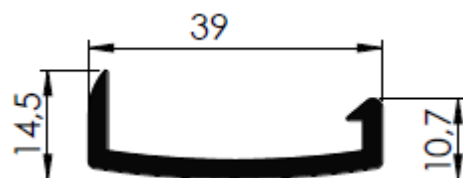

**601130086** - PESO 0,409 kg/m  
10 BARRAS POR PACOTE

# MOVELEIRA

## TRILHO INF. MONO 20,8 X 6MM



**601140003** - PESO 0,067 kg/m  
30 BARRAS POR PACOTE

## TRILHO INFERIOR 36,70 X 5,10MM

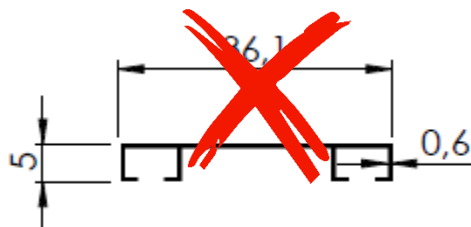

**601140515** - PESO 0,103 kg/m  
30 BARRAS POR PACOTE

## TRILHO INFERIOR 38,5 X 8MM

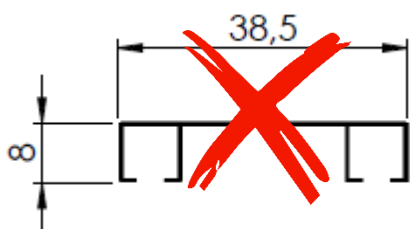

**601140005** - PESO 0,147 kg/m  
30 BARRAS POR PACOTE

## TRILHO INFERIOR 42 X 5,30MM

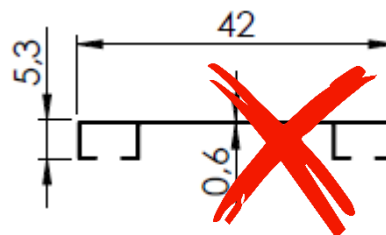

**601140519** - PESO 0,117 kg/m  
30 BARRAS POR PACOTE

## TRILHO INFERIOR 46 X 5,7MMX0,7MM

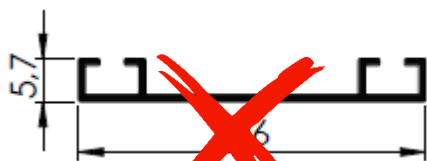

**601140012** - PESO 0,147 kg/m  
30 BARRAS POR PACOTE

## TRILHO INFERIOR 47,1 X 5,7 X 0,7MM

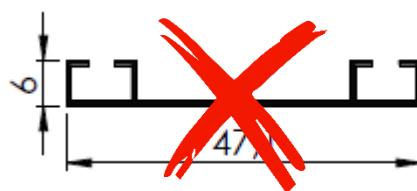

**601140017** - PESO 0,154 kg/m  
30 BARRAS POR PACOTE

## MOVELEIRA

**TRILHO INFERIOR 46 X 5,7MMX0,7MM**



**601140012** - PESO 0,147 kg/m  
30 BARRAS POR PACOTE

**TRILHO INFERIOR 47,1 X 5,7 X 0,7MM**

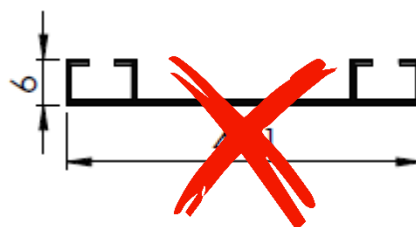

**601140017** - PESO 0,154 kg/m  
30 BARRAS POR PACOTE

**PUXADOR 38 X 17,2MM MV-15**

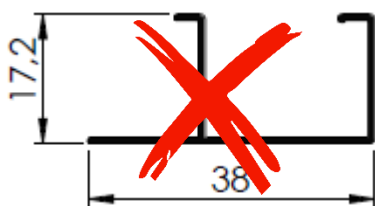

**601140011** - PESO 0,170 kg/m  
30 BARRAS POR PACOTE

**MOLDURA DE ESPELHO**



**601130085** - PESO 0,314 kg/m  
10 BARRAS POR PACOTE

**PUXADOR 32,5 X 17,5MM**

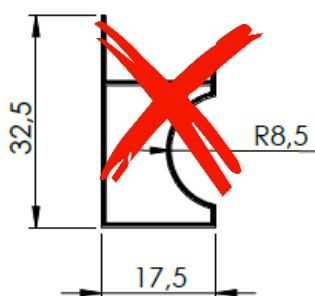

**601130146** - PESO 0,195 kg/m  
20 BARRAS POR PACOTE

**TUBO OBLONGO LISO**  
**26,0 X 13 X 0,85**

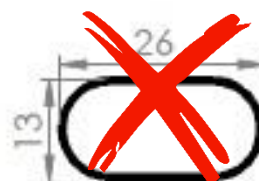

**601080010** - PESO 0,155 kg/m  
10 BARRAS POR PACOTE

# MOVELEIRA

## TUBO OBLONGO 16,5 X 12 X 1,2MM

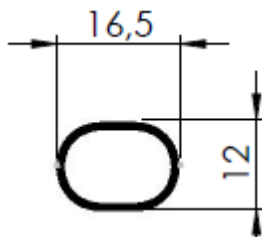

**601080005** - PESO 0,146 Kg/m  
30 BARRAS POR PACOTE

## CABIDEIRO ESTRIADO 19 X 14,5

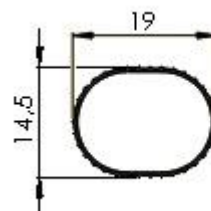

**601080012** PESO 0,073 kg/m  
25 BARRAS POR PACOTE

## CABIDEIRO ECON. ESTR. COMERCIAL

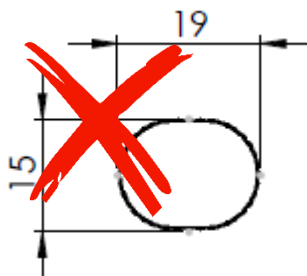

**601080006** PESO 0,088 kg/m  
25 BARRAS POR PACOTE

## CABIDEIRO ESTRIADO 23 X 15,8

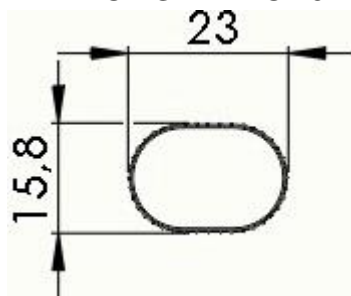

**601080013** PESO 0,098 kg/m  
25 BARRAS POR PACOTE

## CABIDEIRO ESTRIADO LEVE 25 X 15,8

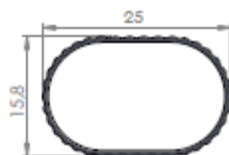

**601080008** - PESO 0,101 Kg/m  
25 BARRAS POR PACOTE

## CABID. ESTR. COMUM COMERCIAL 26,4 X 13,3

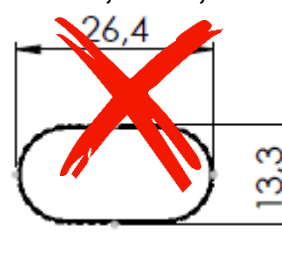

**601080004** - PESO 0,116 kg/m  
25 BARRAS POR PACOTE

## CABIDEIRO ESTRIADO 27MM X 15MM

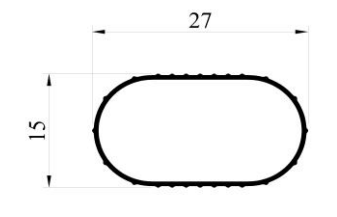

**601080015** - PESO 0,116 kg/m  
25 BARRAS POR PACOTE

## PERFIL H 17,4 X 11,6MM MV-204

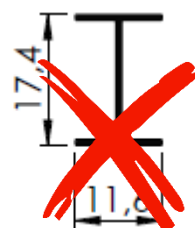

**601140007** - PESO 0,075 kg/m  
50 BARRAS POR PACOTE

# MOVELEIRA

ou - 5%

## PERFIL H 12,5 X 11MM



**601140006** - PESO 0,087 kg/m  
50 BARRAS POR PACOTE

## TRILHO INFERIOR ABAS IGUAS 7,5 X 6,5MM MV-196

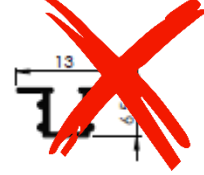

**601140009** - PESO 0,049 kg/m  
50 BARRAS POR PACOTE

## TRILHO INFERIOR ABAS IGUAS 8,5 X 9,0MM MV-197

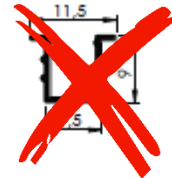

**601140008** - PESO 0,058 kg/m  
50 BARRAS POR PACOTE

## "U" 16MMX14,3MMX0,9MM

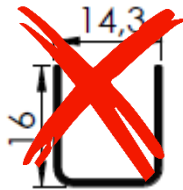

**601140013** - PESO 0,111 kg/m  
30 BARRAS POR PACOTE

## "U" C/ ABA 16MMX14,3MM0,9MM

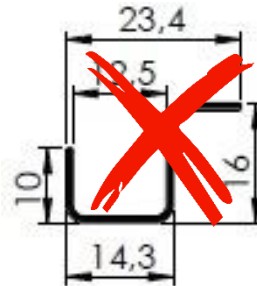

**601140014** - PESO 0,116 kg/m  
30 BARRAS POR PACOTE

## PERFIL "U" ABAS DESIGUAIS 16,3 X 17,5MM MV-76

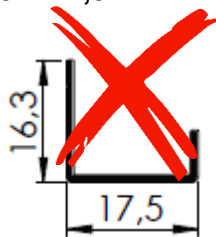

**601140010** - PESO 0,099 kg/m  
50 BARRAS POR PACOTE

## DESEMPENO

**14X15,5X4,0X0,75MM**



**601140029** - PESO 0,067 kg/m  
50 BARRAS POR PACOTE

## DESEMPENO 14,9 X 10,5 X 5,2 X 1,2MM



**601140030** - PESO 0,096 kg/m  
50 BARRAS POR PACOTE

# FERRAGEM

## TRILHO PARA PORTÃO

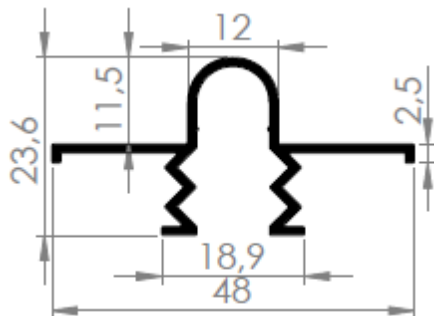

**601130039** - PESO 0,346 kg/m  
14 BARRAS POR PACOTE

## PROLONGADOR 50,8MM

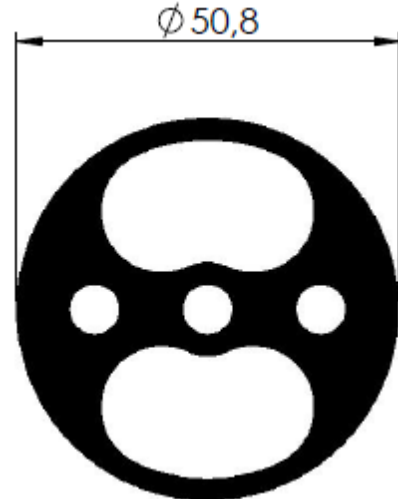

**601200011** - PESO 3,170 kg/m  
2 BARRA POR PACOTE

## PERFIL A

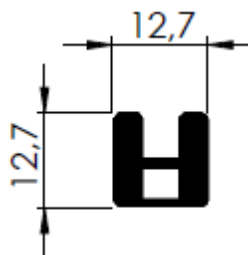

**601130026** - PESO 0,324 kg/m  
15 BARRAS POR PACOTE

## PUXADOR QUADRADO C/ FURO

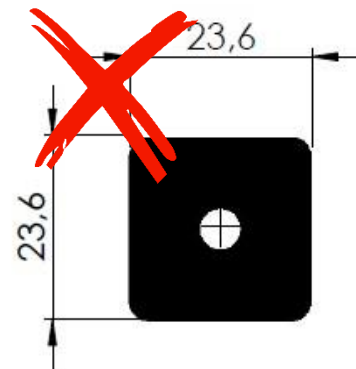

**601130028** - PESO 1,507 kg/m  
4 BARRAS POR PACOTE

## DESCANSO DE JANELA MAX AIR

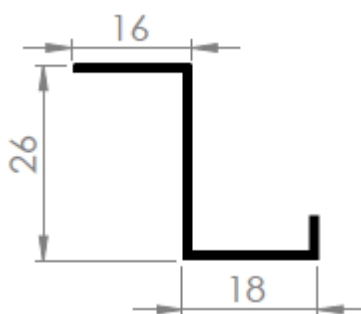

**601120012** - PESO 0,228 kg/m  
20 BARRAS POR PACOTE

## BATENTE FECHO V. A

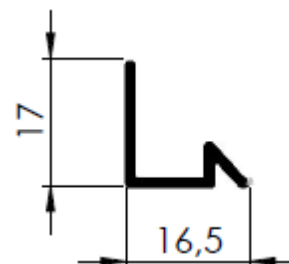

**601200012** - PESO 0,161 kg/m  
30 BARRAS POR PACOTE

# FERRAGEM

## BASE PARA PUXADOR

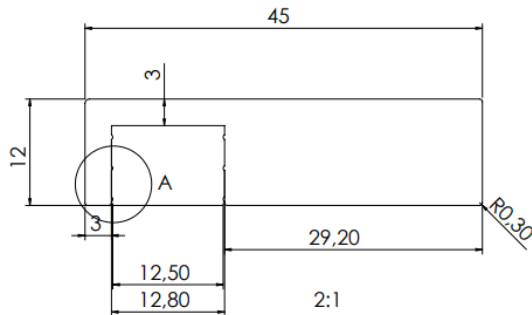

**601130175** - PESO 1,204 kg/m  
3 BARRAS POR PACOTE

## PERFIL 1710

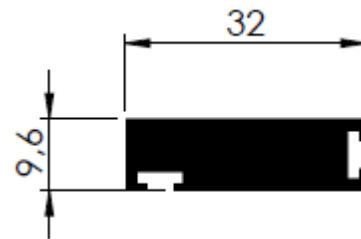

**601123032** - PESO 0,802 kg/m  
6 BARRAS POR PACOTE

## DOBRADIÇA 32 x 3,6MM

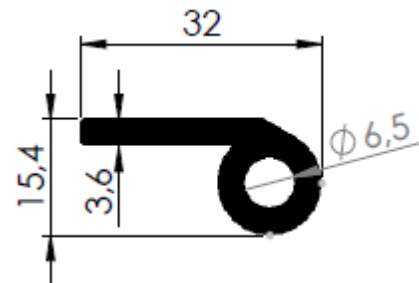

**601200003** - PESO 0,578 kg/m  
10 BARRAS POR PACOTE

## DOBRADIÇA 51,5 x 3,7MM

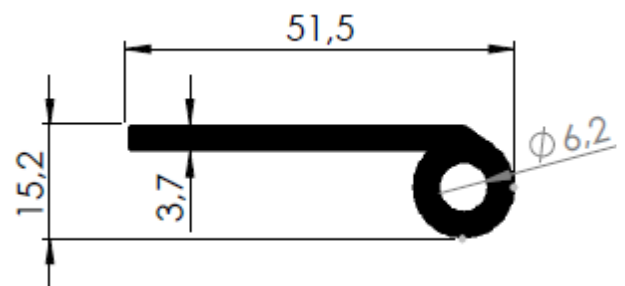

**601200002** - PESO 0,788 kg/m  
8 BARRAS POR PACOTE

## PERFIL FERRAGEM 1531

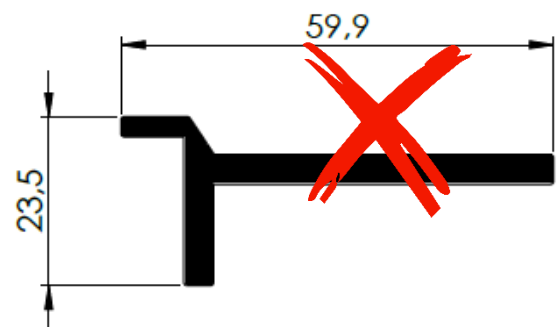

**601200009** - PESO 0,864 kg/m  
8 BARRAS POR PACOTE

## DOBRADIÇA FURO ESTRELA 40 X 3,8MM

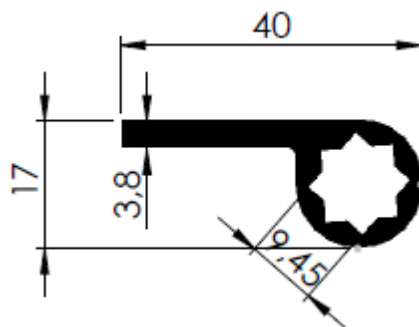

**601200006** - PESO 0,639kg/m  
10 BARRAS POR PACOTE

## DOBRADIÇA FURO ESTRELA 54,7X 3,8MM

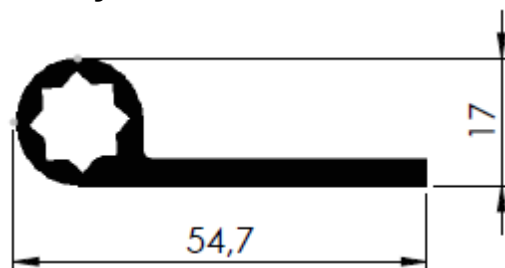

**601200005** - PESO 0,796kg/m  
8 BARRAS POR PACOTE

# FERRAGEM

**FECHO FEMEA50,0x4,4MM**

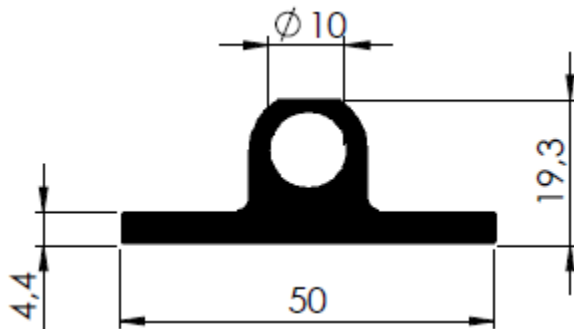

**601200001** - PESO 1,034 kg/m  
7 BARRAS POR PACOTE

**BATE E FECHA**

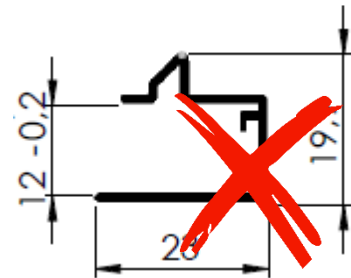

**601130010** - PESO 0,238 kg/m  
20 BARRAS POR PACOTE

**FERRAGEM 1587 - 104,5 X 11,6MM**

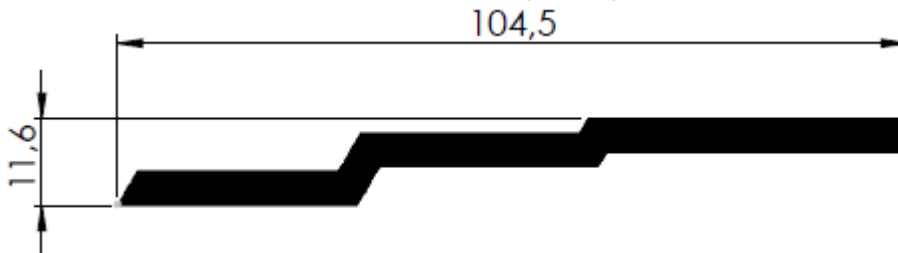

**601200008** - PESO 1,400 kg/m  
3 BARRAS POR PACOTE

**DOBRADIÇA 100 x 4,4MM**

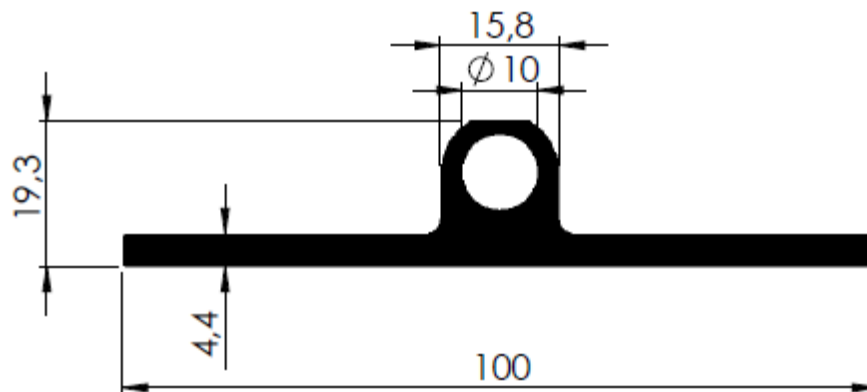

**601200007** - PESO 1,659kg/m  
3 BARRAS POR PACOTE

# FERRAGEM

**CONTRA TRINCO 53 X 14,5MM**

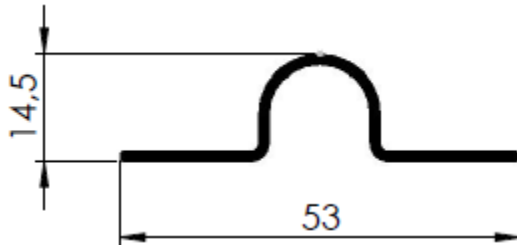

**601200010** - PESO 0,320 kg/m  
10 BARRAS POR PACOTE

**TRINCO 56,5 X 16,5MM**

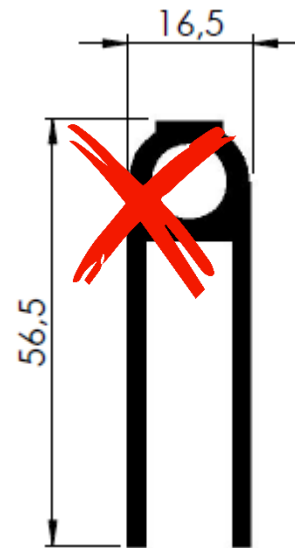

**601200015** - PESO 1,024 kg/m  
4 BARRAS POR PACOTE

**BATE FECHA (BASE 1570)**

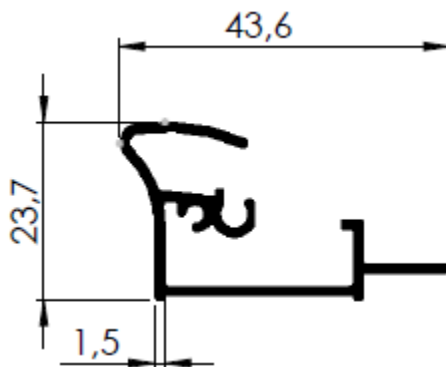

**601120007** - PESO 0,457 kg/m  
12 BARRAS POR PACOTE

**BATE FECHA (MOVEL 1570)**

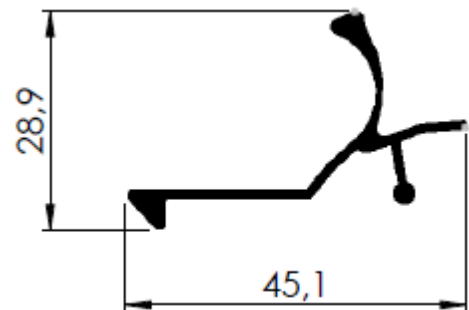

**601120009** - PESO 0,359 kg/m  
10 BARRAS POR PACOTE

**BATE FECHA (FIXO 1570)**

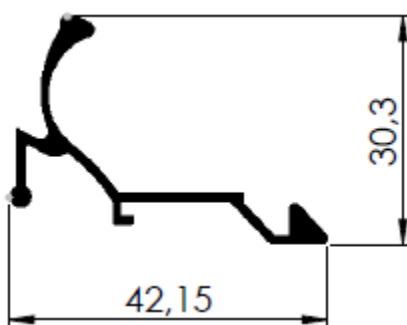

**601120008** - PESO 0,373 kg/m  
10 BARRAS POR PACOTE

**TUBO COM GUIA 25,4 X 3 X 0,65MM**

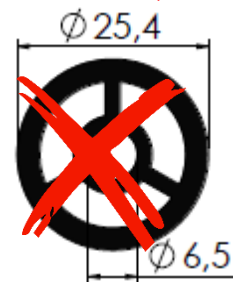

**600010018** - PESO 0,828 kg/m  
6 BARRAS POR PACOTE

## LINHA GRADIL

**NHG 083**

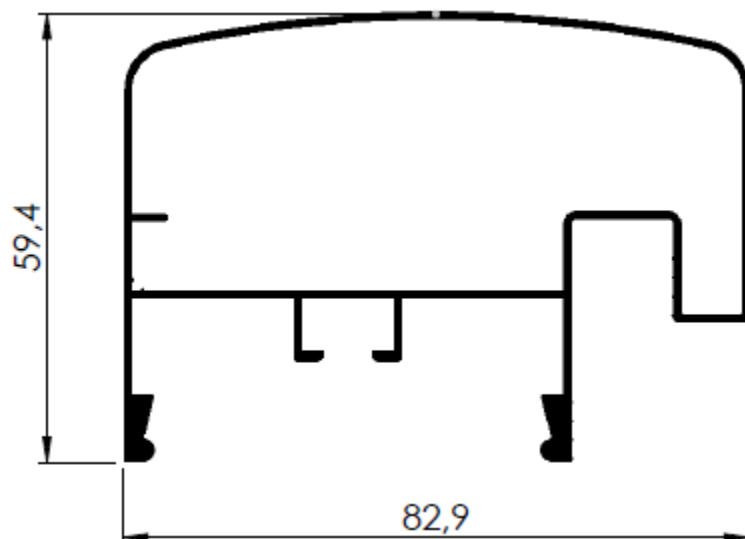

**601170004** - PESO 1,240kg/m  
4 BARRAS POR PACOTE

**NHG 077**

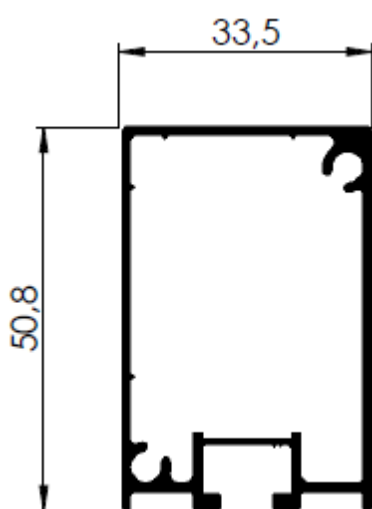

**601170003** - PESO 0,838kg/m  
6 BARRAS POR PACOTE

**NHG 075**

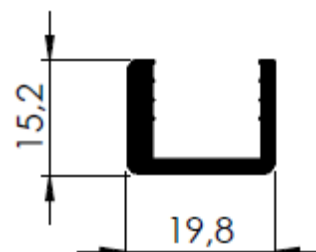

**601170002** - PESO 0,331kg/m  
12 BARRAS POR PACOTE

**NHG 074**

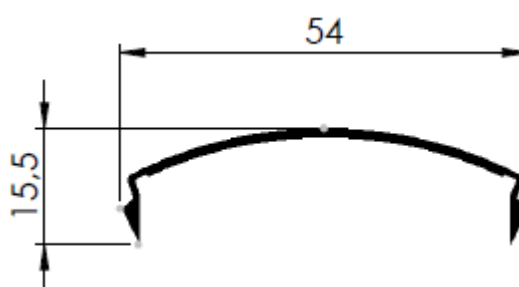

**601170001** - PESO 0,258kg/m  
20 BARRAS POR PACOTE

# LINHA SEGURANÇA

(\*) Peso teórico, sujeito a variação de +

ou - 5%

## PERFIL "C" (CERCA ELETRICA)

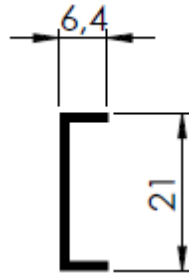

**601210004** - PESO 0,119kg/m  
50 BARRAS POR PACOTE

## PERFIL "M" (CERCA ELETRICA)

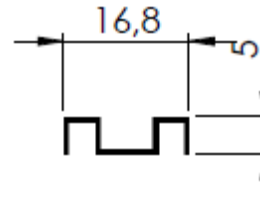

**601210005** - PESO 0,076 kg/m  
50 BARRAS POR PACOTE

## PERFIL ESTRELA (CERCA ELÉTRICA)

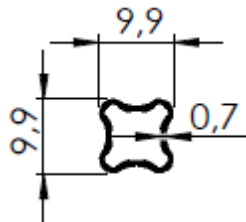

**601210003** - PESO 0,089kg/m  
50 BARRAS POR PACOTE

## PERFIL MEIA CANA (CERCA ELETRICA)

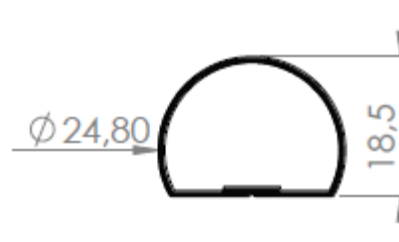

**601210006** - PESO 0,170 kg/m  
20 BARRAS POR PACOTE

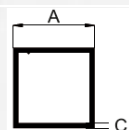

## TUBOS QUADRADOS PARA CERCA ELÉTRICA

CÓDIGO	kg/m	A	C	BARRAS POR PACOTE
<b>601060009</b>	0,178	23,0	0,7	15
<b>601063492</b>	0,193	25,0	0,7	15
<b>601060004</b>	0,228	29,4	0,7	12
<b>601060011</b>	0,443	40,0	1	9

## TUBO COM RELEVO

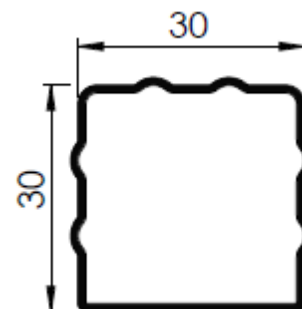

**601210007** - PESO 0,302 kg/m  
12 BARRAS POR PACOTE

# AQUECEDOR

**LATERAL PEQUENA**

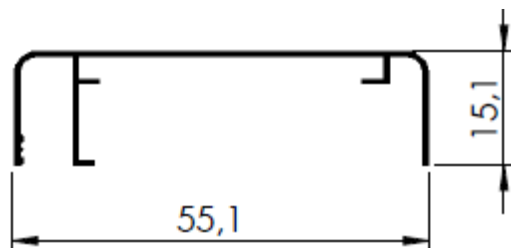

**601260002** - PESO 0,257 kg/m  
20 BARRAS POR PACOTE

**PERFIL "T"**

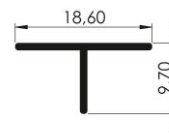

**601130716** - PESO 0,066 kg/m  
50 BARRAS POR PACOTE

**LATERAL GRANDE**

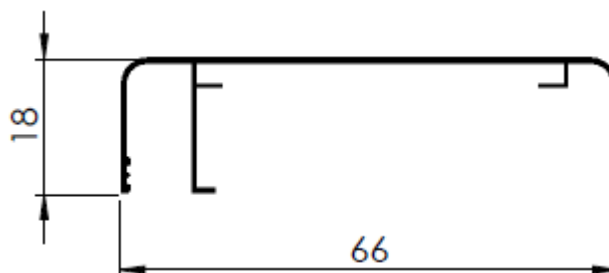

**601260001** - PESO 0,278kg/m  
20 BARRAS POR PACOTE

**ALETA**



**601260003** - PESO 0,263kg/m  
10 BARRAS POR PACOTE

## TEMPERADO BOX

**BX 059**

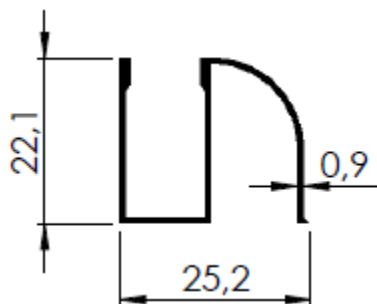

**601122976** - PESO 0,221 kg/m  
20 BARRAS POR PACOTE

**BX 219**

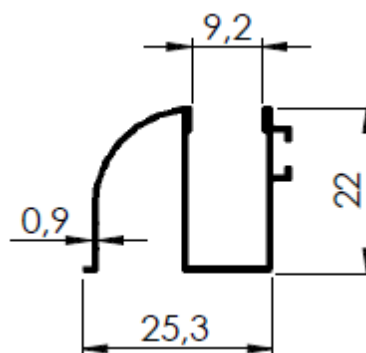

**601124886** - PESO 0,245kg/m  
20 BARRAS POR PACOTE

**BX 091T**

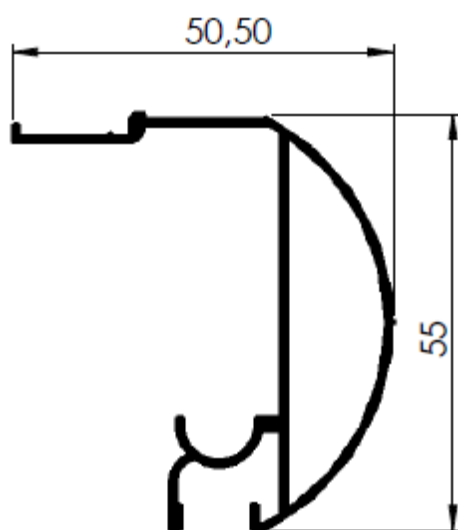

**601124938** - PESO 0,559kg/m  
10 BARRAS POR PACOTE

**BX 092**

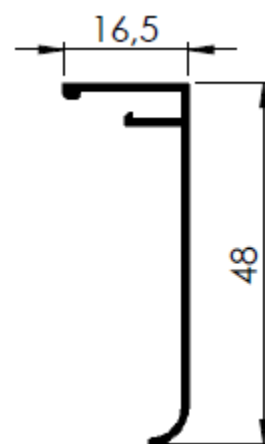

**601122981** - PESO 0,180kg/m  
20 BARRAS POR PACOTE

## TEMPERADO BOX

**BX 103**

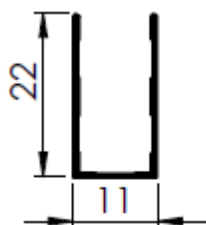

**601122986** - PESO 0,116 kg/m  
40 BARRAS POR PACOTE

**BX 137**

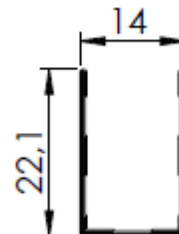

**601122988** - PESO 0,126 kg/m  
40 BARRAS POR PACOTE

**BX 093**

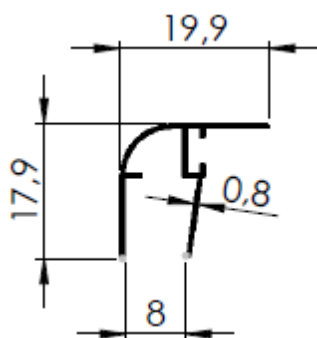

**601122982** - PESO 0,131kg/m  
30 BARRAS POR PACOTE

**BX 102**

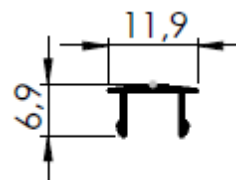

**601122984** - PESO 0,057 kg/m  
40 BARRAS POR PACOTE

## TEMPERADO

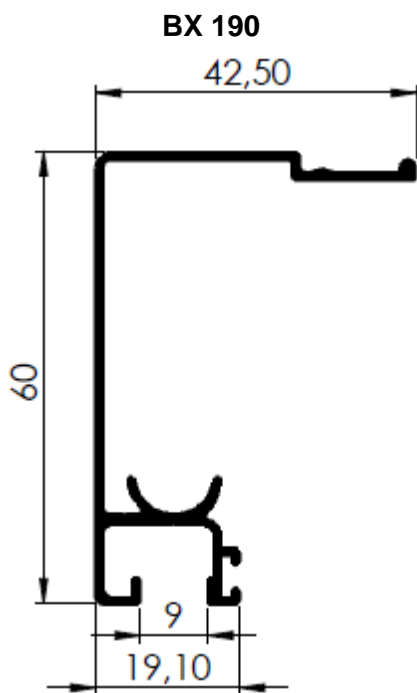

**601124881** - PESO 0,514 kg/m  
10 BARRAS POR PACOTE

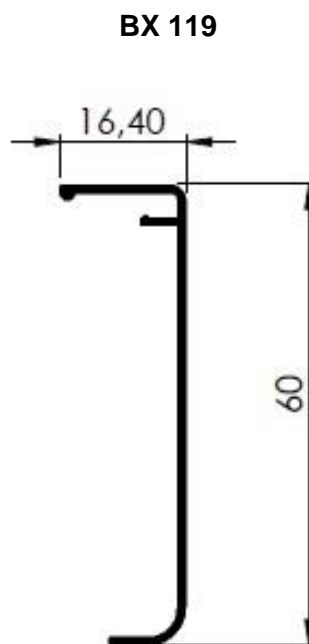

**601121680** - PESO 0,220kg/m  
20 BARRAS POR PACOTE

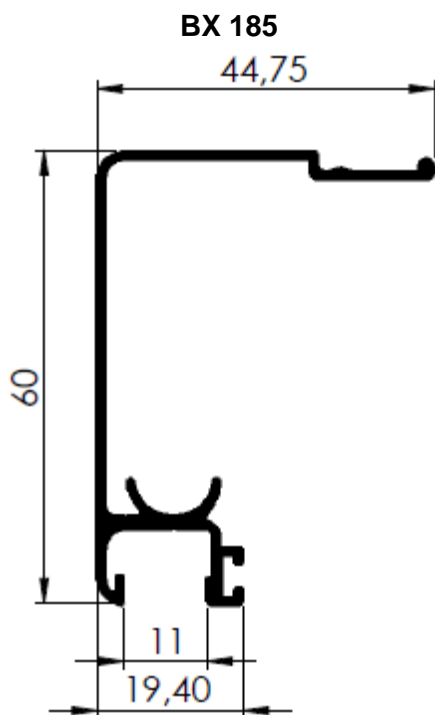

**601125012** - PESO 0,514kg/m  
10 BARRAS POR PACOTE

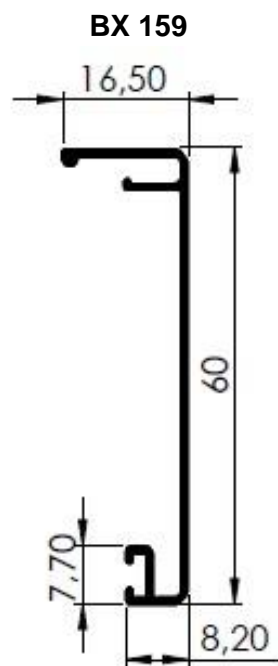

**601124883** - PESO 0,245 kg/m  
20 BARRAS POR PACOTE

## TEMPERADO

**BX 285**

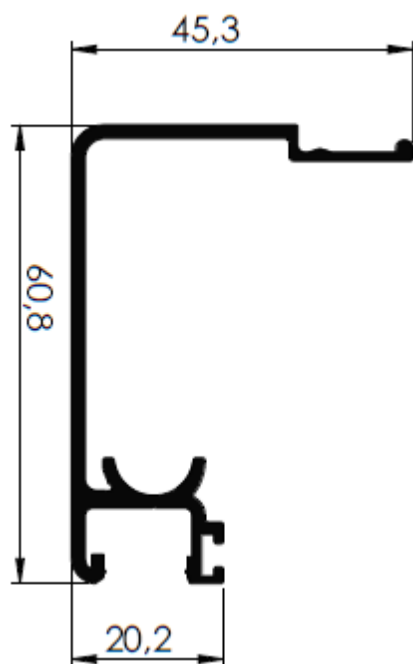

**601120019** - PESO 0,768kg/m  
10 BARRAS POR PACOTE

**NH 219**

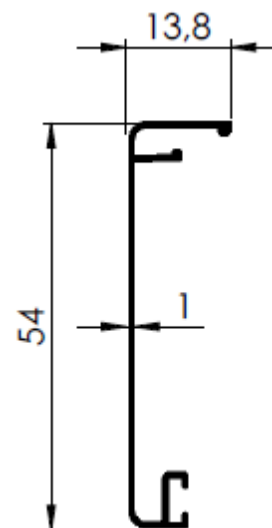

**601120004** - PESO 0,260kg/m  
20 BARRAS POR PACOTE

**NH 119**

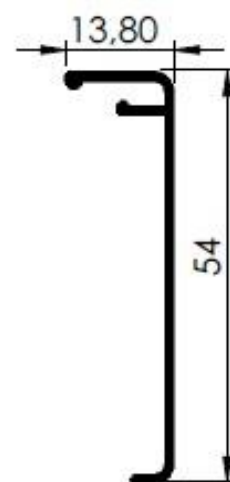

**601120002** - PESO 0,221 kg/m  
20 BARRAS POR PACOTE

# TEMPERADO

NH 190

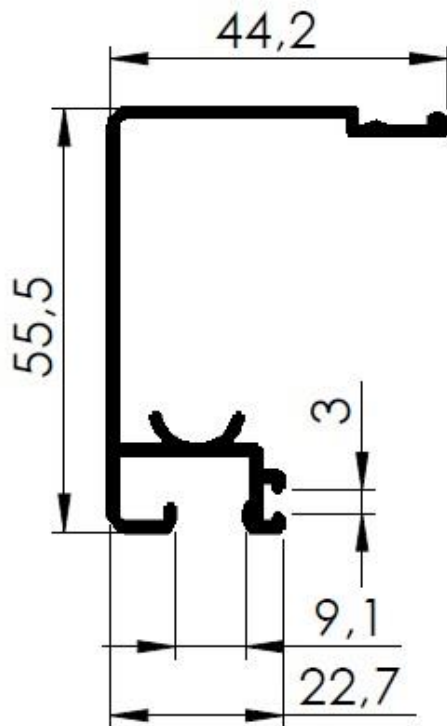

**601120001** - PESO 0,546 kg/m  
10 BARRAS POR PACOTE

NH 290

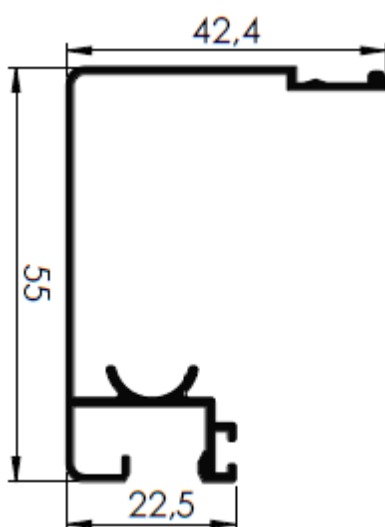

NH 390

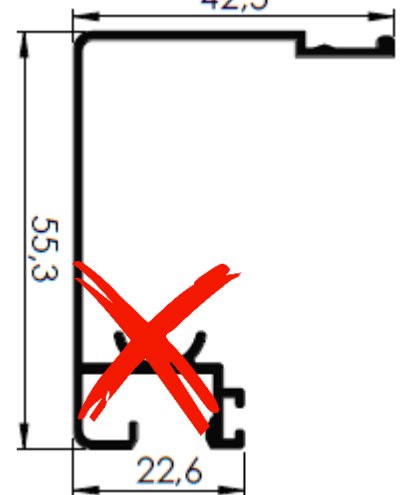

**NH 390**

**601120022** - PESO 0,510 kg/m  
10 BARRAS POR PACOTE

NH 159

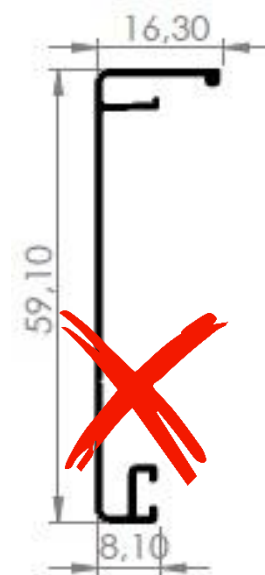

**601120011** - PESO 0,288kg/m  
20 BARRAS POR PACOTE

# TEMPERADO

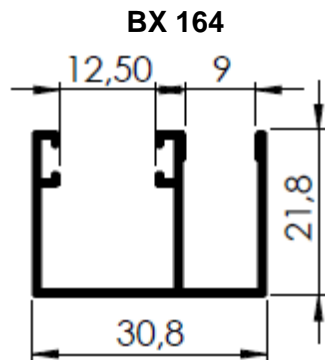

**BX 164**  
**601122015** - PESO 0,318kg/m  
 10 BARRAS POR PACOTE

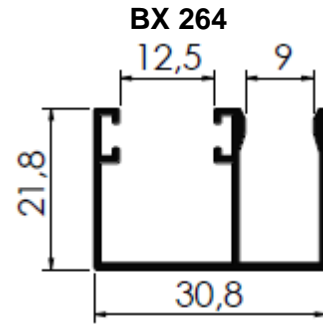

**BX 264**  
**601120018** - PESO 0,293 kg/m  
 10 BARRAS POR PACOTE

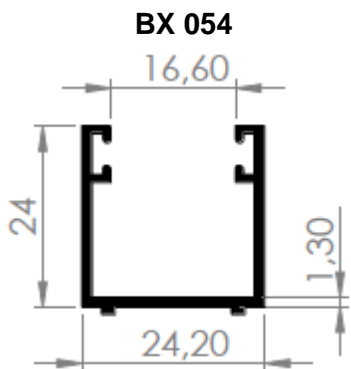

**BX 054**  
**601120014** - PESO 0,308kg/m  
 10 BARRAS POR PACOTE

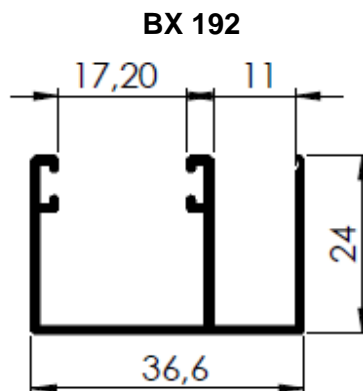

**BX 192**  
**601124882** - PESO 0,368kg/m  
 10 BARRAS POR PACOTE

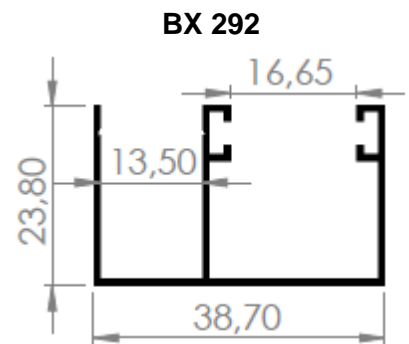

**BX 292**  
**601120010** - PESO 0,335kg/m  
 10 BARRAS POR PACOTE

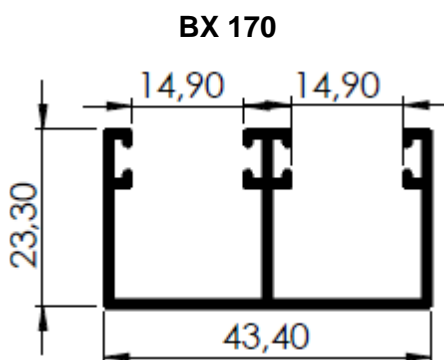

**BX 170**  
**601124751** - PESO 0,475kg/m  
 10 BARRAS POR PACOTE

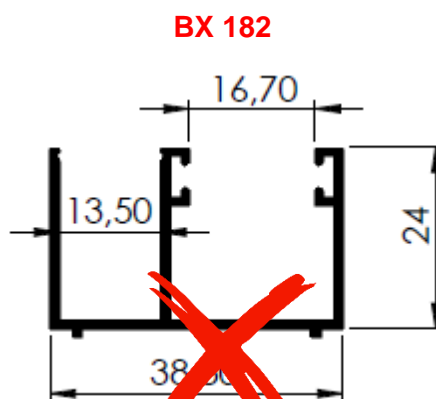

**BX 182**  
**601125017** - PESO 0,410kg/m  
 10 BARRAS POR PACOTE

# TEMPERADO

**BX 155**

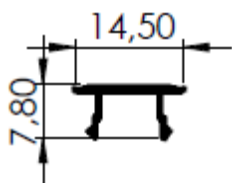

**601122985** - PESO 0,090kg/m  
40 BARRAS POR PACOTE

**BX 010**

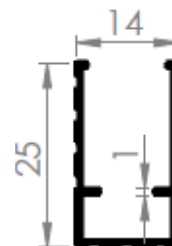

**601120017** - PESO 0,178kg/m  
20 BARRAS POR PACOTE

**PU 040**

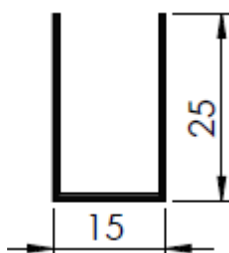

**601224681** - PESO 0,176kg/m  
30 BARRAS POR PACOTE

**PU 004**

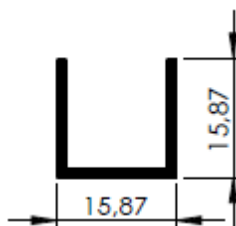

**601228715** - PESO 0,148kg/m  
30 BARRAS POR PACOTE

**BX 375**

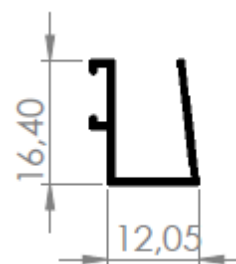

**601120015** - PESO 0,121 kg/m  
20 BARRAS POR PACOTE

**BX 209**

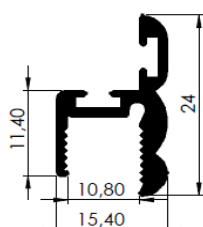

**601121678** - PESO 0,245kg/m  
20 BARRAS POR PACOTE

**BX 128**

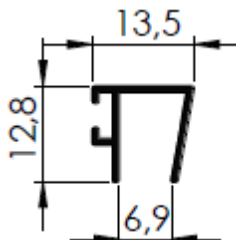

**601128770** - PESO 0,108kg/m  
30 BARRAS POR PACOTE

**BX 275**



**601121679** - PESO 0,180kg/m  
20 BARRAS POR PACOTE

# TEMPERADO

**BX 130**

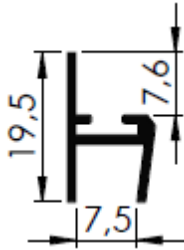

**601126868** PESO 0,140kg/m  
30 BARRAS POR PACOTE

**BX 131**

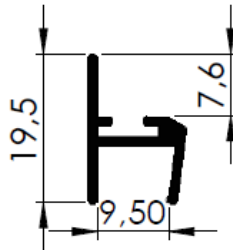

**601126867** - PESO 0,154kg/m  
30 BARRAS POR PACOTE

**BX 126**

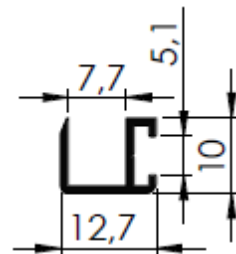

**601128767** - PESO 0,100kg/m  
30 BARRAS POR PACOTE

**TRILHO SUP. BOX LISO 43,7MMX44,5MM**

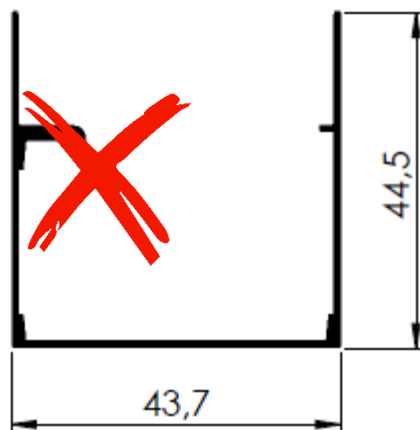

**601120013** - PESO 0,468kg/m  
10 BARRAS POR PACOTE

**BX 241**

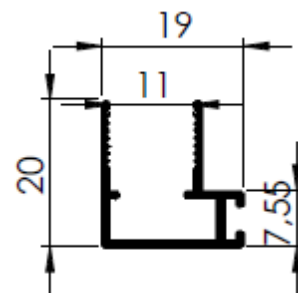

**601121682** - PESO 0,190kg/m  
20 BARRAS POR PACOTE

**TRAPEZIO PARA POLICARBONATO**

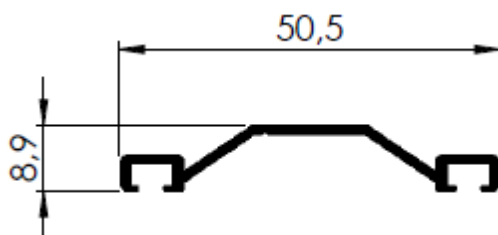

**601130018** - PESO 0,294kg/m  
16 BARRAS POR PACOTE

**PU C/ ABA 6MM  
(POLICARBONATO)**

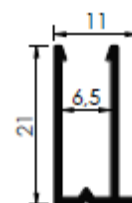

**601220006** - PESO 0,152 kg/m  
30 BARRAS POR PACOTE

## VENEZIANA

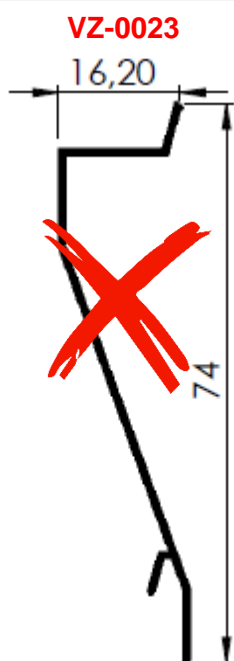

**601190002** - PESO 0,250kg/m  
15 BARRAS POR PACOTE

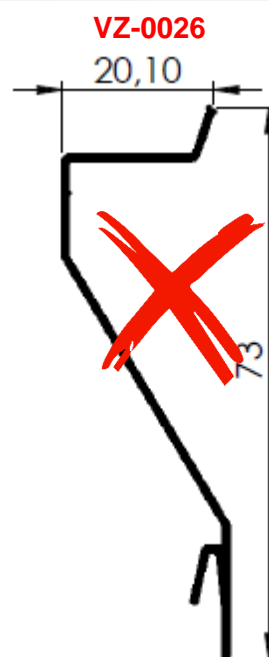

**601190001** - PESO 0,293kg/m  
15 BARRAS POR PACOTE

## TRILHO PANTOGRÁFICO

**1 ROLDANA CONCAVA**

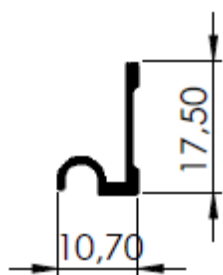

**601040240** - PESO 0,099kg/m  
30 BARRAS POR PACOTE

**1 ROLDANA RETA**

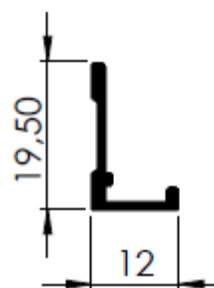

**601040242** - PESO 0,146 kg/m  
30 BARRAS POR PACOTE

# TRILHO PANTOGRÁFICO

**02 ROLD. CONCAVAS**  
**34,6X34,6X0,8MM**

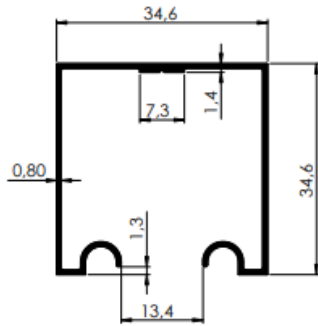

**601040011** - PESO 0,315kg/m  
8 BARRAS POR PACOTE

**2 ROLDANAS CONCAVAS**

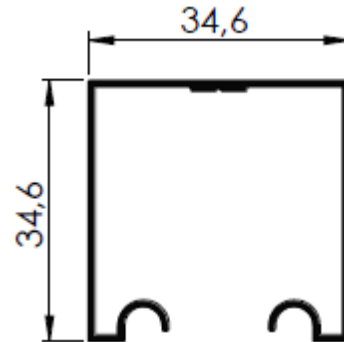

**601040009** - PESO 0,334 kg/m  
8 BARRAS POR PACOTE

**2 ROLDANAS CONCAVAS**

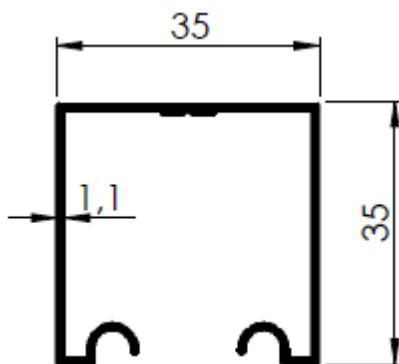

**601040001** - PESO 0,388kg/m  
8 BARRAS POR PACOTE

**2 ROLDANAS CONCAVAS**

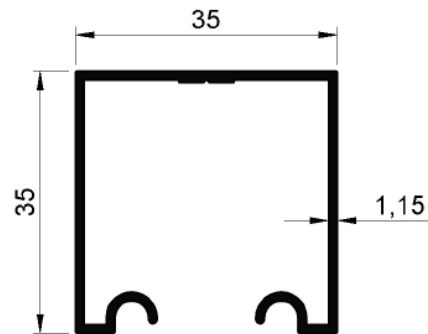

**601040010** - PESO 0,441 kg/m  
8 BARRAS POR PACOTE

**2 ROLDANAS CONCAVAS**

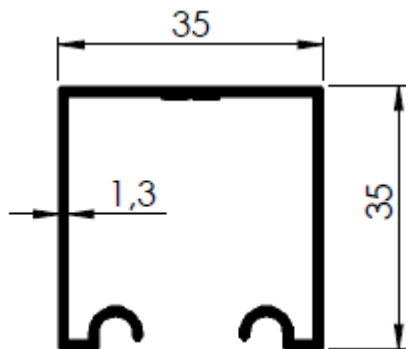

**601040002** - PESO 0,460kg/m  
8 BARRAS POR PACOTE

**2 ROLDANAS RETAS**

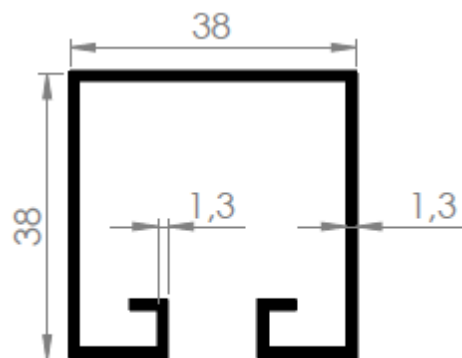

**601048554** - PESO 0,588kg/m  
8 BARRAS POR PACOTE

## TRILHO PANTOGRÁFICO

### 2 ROLDANAS CONCAVAS C/ ABAS

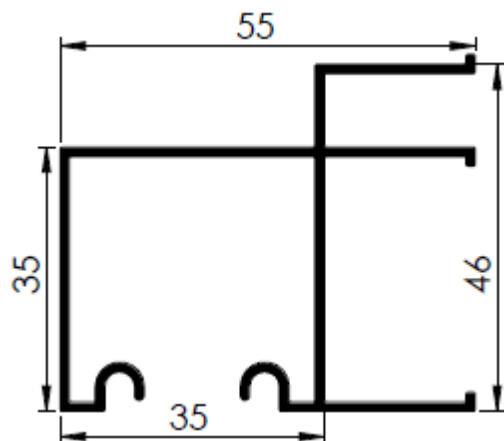

**601040005** - PESO 0,726 kg/m

6 BARRAS POR PACOTE

### 2 ROLDANAS CONCAVAS

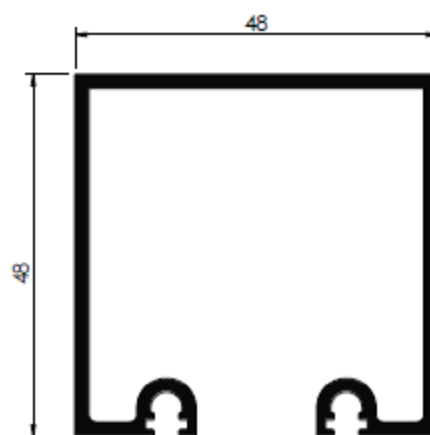

**601040003** - PESO 0,976kg/m

6 BARRAS POR PACOTE

### SUPOORTE P/ TP 02 ROLDANAS 63MMX39MM

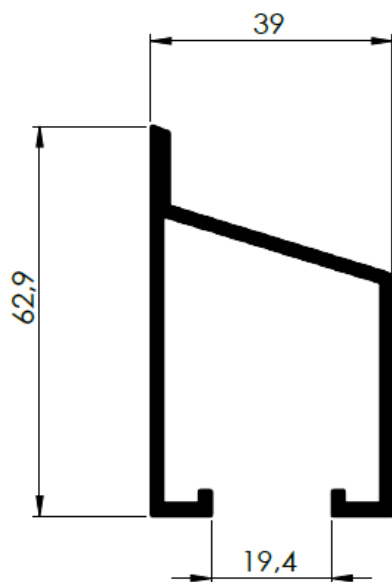

**601040006** - PESO 0,937 kg/m

6 BARRAS POR PACOTE

## MODULO ESPECIAL (DESLIZANTES)

**TRILHO DUPLO P/ CONJ. DESLIZANTE**

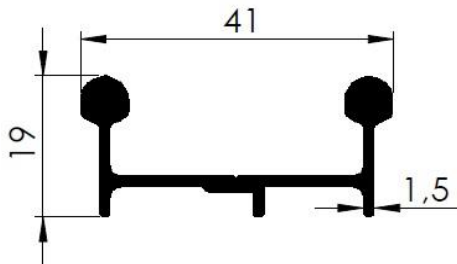

**600060004** - PESO 0,490kg/m

**TRANSPASSE 40,8X17,8MM**

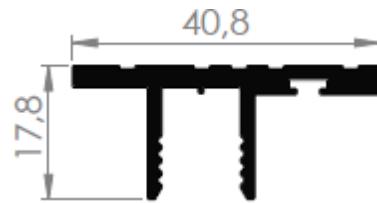

**601130067** - PESO 0,493 kg/m  
10 BARRAS POR PACOTE

**TRILHO TRIPLO P/ CONJUNTO DESLIZANTE**

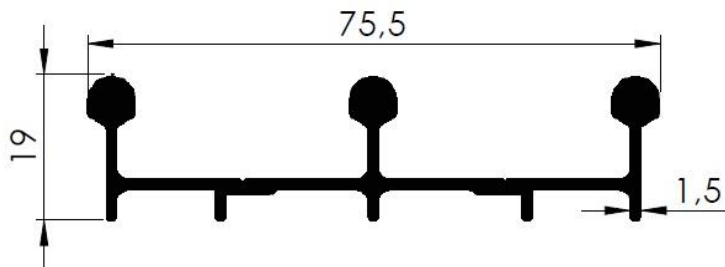

**600060005** - PESO 0,828 kg/m

**TRILHO SIMPLES P/ CONJ. DESLIZANTE**

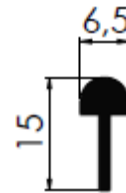

**600060007** - PESO 0,128 kg/m  
30 BARRAS POR PACOTE

**PERFIL "F" DESLIZANTE**

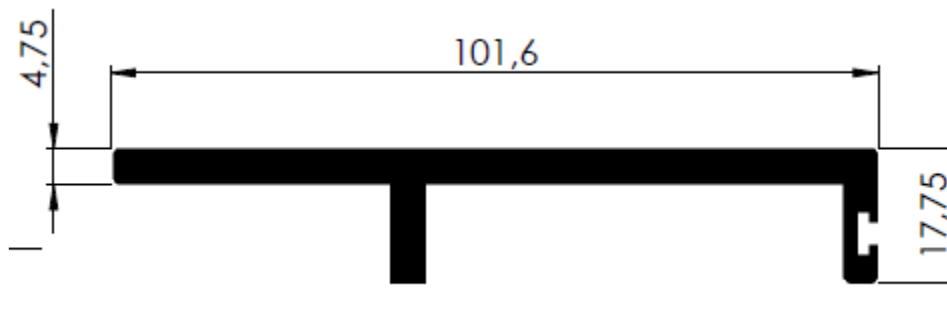

**600060006** - PESO 1,684 kg/m  
3 BARRAS POR PACOTE

## MODULO ESPECIAL (DESLIZANTES)

### PERFIL "F" DESLIZANTE LEVE

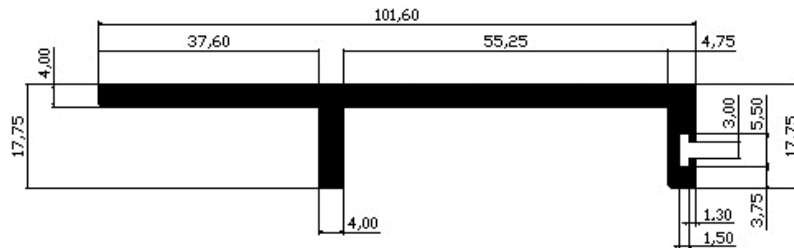

**600060008** - PESO 1,465 kg/m - 3 BARRAS POR PACOTE

## PAINEL RIPADO

### PERFIL PAINEL RIPADO 20MM

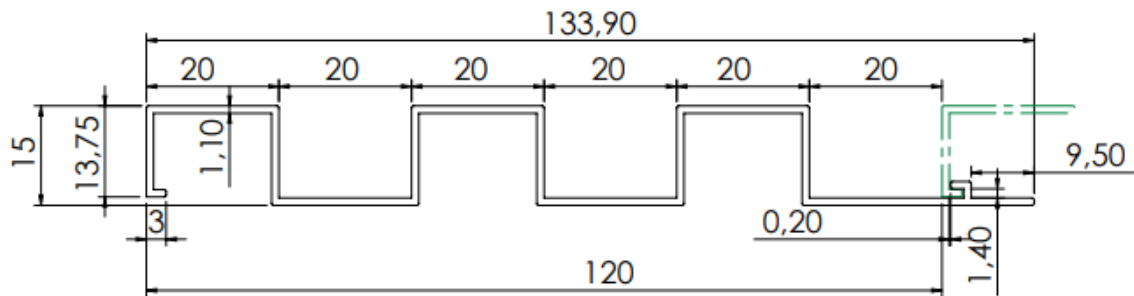

**601130176** - PESO 0,730 kg/m

3 BARRAS POR PACOTE

### PERFIL PAINEL RIPADO 30MM

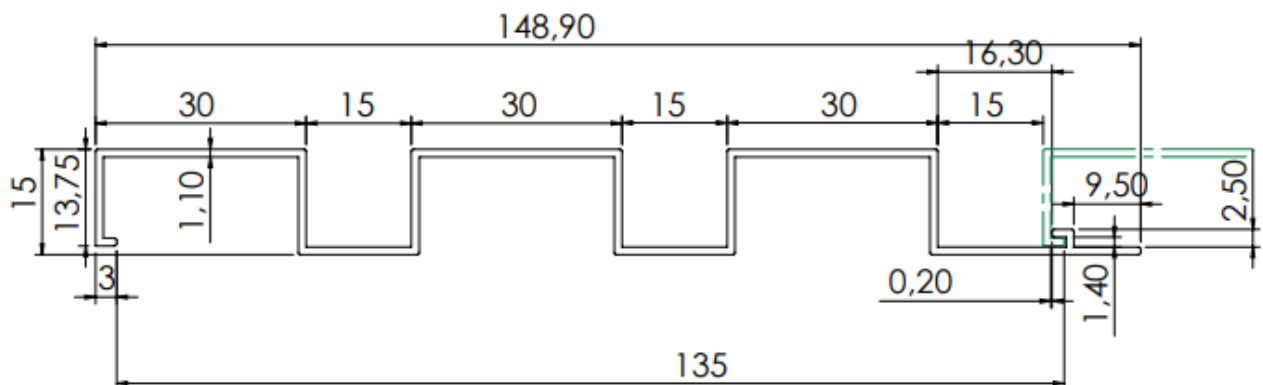

**601130177** - PESO 0,778 kg/m

3 BARRAS POR PACOTE

(\*) **COMERCIALIZAMOS ESTES PERFIS NA COR CEREJEIRA REAL, COM ACABAMENTOS DE CANTONEIRA ½", ¾" E 1" NA MESMA COR.**

## INFORMAÇÕES IMPORTANTES

COMPOSIÇÃO E APLICAÇÃO DAS PRINCIPAIS LIGAS COMERCIALIZADAS PELA NOVO HORIZONTE										
LIGA	ELEMENTOS	Cu	Fe	Mg	Mn	Cr	Si	Ti	Zn	Al
6060	% Mínimo		0,10	0,35			0,30			Restante
	% Máximo	0,10	0,30	0,60	0,10	0,05	0,60	0,10	0,15	
6063	% Mínimo			0,45			0,20			Restante
	% Máximo	0,10	0,35	0,90	0,10	0,10	0,60	0,10	0,10	
<b>6060: Perfis para construção civil, ornamentos, caixilharia em geral, móveis etc.</b>										
<b>6063: Tubos de irrigação, aro para bicicleta, acabamentos para carrocerias, barcos etc.</b>										
<b>Ambas possuem média resistência mecânica, alta resistência à corrosão, boa conformabilidade (melhor é a 6063) e são apropriadas para anodização decorativa fosca.</b>										

## INFORMAÇÕES DIVERSAS

### DICAS PARA ARMAZENAMENTO E CONSERVAÇÃO CORRETA DOS PERFIS DE ALUMÍNIO

- ✓ NUNCA pise nos amarrados/ pacotes de perfis durante a movimentação ou armazenamento e NÃO puxe/ arraste as barras de dentro dos amarrados fechados;
- ✓ Evite a movimentação dos amarrados diretamente com a empilhadeira. Eles devem estar armazenados em cestos/ gaiolas, ou embalagens apropriadas para estes fins;
- ✓ NUNCA movimente ou armazene os amarrados sob chuva, ou em locais com umidades;
- ✓ NUNCA armazene os amarrados, e principalmente os perfis sem embalar, próximo de locais onde fiquem expostos a pó de cimento, pó ocasionado por quebras de paredes, ou ainda próximo à névoa Salina (Soda);
- ✓ Quando armazenar perfis na horizontal, evite pilhas muito altas e separe as camadas com papelão ou travessas adequadas. NUNCA armazene pacotes diretamente ao piso;
- ✓ Para evitar marcas ou riscos superficiais, evite contato direto entre perfis e outros metais;
- ✓ UTILIZE luvas LIMPAS no manuseio. O ideal é que se faça o uso de talco industrial periodicamente durante o turno, para “secar” a luva molhada de suor. Desta forma evita-se mancha alcalina no perfil.